



PT0E-1897

Portable Gas Monitor 04 Series

Operation Manual

(PT0-189)

RIKEN KEIKI Co., Ltd.

2-7-6 Azusawa, Itabashi-ku, Tokyo, 174-8744, Japan

Website: <https://www.rikenkeiki.co.jp/>

Contents

1. Product Overview	4
1-1. Introduction	4
1-2. Intended use	6
1-3. DANGER, WARNING, CAUTION, and NOTE	7
1-4. Checking standards and explosion-proof specifications.....	8
2. Important Safety Information	9
2-1. Danger information	9
2-2. Warning information	12
2-3. Caution information	16
2-4. Safety information	21
3. Product Configuration	24
3-1. Main unit and accessories	24
3-2. Part names and functions	26
3-2-1. Main unit	26
3-2-2. LCD display	28
3-3. Inserting the batteries.....	29
4. Alarm Functions	33
4-1. Gas alarm types and alarm setpoints	33
4-2. Gas alarm activation	40
4-3. Fault alarm activation	42
4-4. Outside operating temperature range warning	43
5. Usage Instructions.....	44
5-1. Usage note.....	44
5-2. Preparing startup.....	44
5-3. Turning on the power	45
5-4. Performing air calibration	51

5-5. Measuring gas concentration.....	54
5-6. Checking the gas concentration, alarm setpoints, etc. (display mode)	56
5-6-1. Procedure for displaying display mode	56
5-6-2. Items displayed in display mode	57
5-7. Turning off the power	62
6. User Mode Settings.....	63
6-1. User mode setting procedure	63
6-2. User mode setting items	66
7. Maintenance.....	70
7-1. Maintenance intervals and maintenance items	70
8. Storage and Disposal.....	72
8-1. Procedures for storage or when not in use for extended periods.....	72
8-2. Product disposal.....	73
9. Troubleshooting.....	74
9-1. Product abnormalities	74
10. Product Specifications.....	77
10-1. Common specifications.....	77
10-2. Specifications by model	79
11. Appendix	83
11-1. Limited Warranty and Limitation Liability.....	83

1

Product Overview

1-1. Introduction

Thank you for your purchase of the 04 Series Portable Gas Monitor (“product” hereinafter).

This operation manual describes product operating procedures and specifications. It provides information essential to correct use of the product.

Make sure you have read and fully understood the contents of this manual before using the product.

Keep this operation manual on hand to allow ready reference during use.

For more information on product maintenance and setting changes, refer to the Technical Manual available for download from our website.

The contents of this manual are subject to change without notice to allow product improvements. Any duplication or reproduction of this manual without permission is prohibited, whether in whole or in part.

Riken Keiki accepts no liability for accidents or damage resulting from use of the product, whether within or outside the warranty period.

Review the warranty policy indicated on the warranty.

<Checks made after purchase>

Before using the product, please confirm that the model of the product you purchased matches the model of the product covered by this operation manual.

Models covered by this operation manual

- OX-04G
- OX-04
- CO-04
- HS-04
- CO-04 (C-)
- CX-04
- SC-04 (SO₂, NO₂, HCN, PH₃, NH₃, CL₂)

<This operation manual>

In this operation manual, where descriptions differ according to the model, the following icons are used to indicate each of the models:

OX-04G	OX G	SC-04 (SO₂)	SO₂
OX-04	OX	SC-04 (NO₂)	NO₂
CO-04	CO	SC-04 (HCN)	HCN
HS-04	HS	SC-04 (PH₃)	PH₃
CO-04 (C-)	C-	SC-04 (NH₃)	NH₃
CX-04	CX	SC-04 (CL₂)	CL₂

Operating procedures and specifications for which no icons appear apply to all models.

In cases without significant differences from model to model, the display examples are taken from the CO-04 (CO) (detection target gas: CO (carbon monoxide)).

1-2. Intended use

The product is a portable gas monitor for personal use designed to detect gases in the surrounding atmosphere. It measures concentrations of toxic gases and oxygen in the atmosphere and issues an alarm when gas concentrations reach preset levels, thereby alerting users to the hazards of gas poisoning and oxygen deficiency.

The detection results are not intended to assure life or safety.

The following models are available to detect various detection target gases.

Check the specifications before use to confirm the correct gases will be detected in accordance with the intended purpose.

<List of detection target gases by model>



Model	Detection target gas
OX-04G	Oxygen (galvanic cell type)
OX-04	Oxygen (electrochemical type)
CO-04	Carbon monoxide
HS-04	Hydrogen sulfide
CO-04 (C-)	Carbon monoxide*
CX-04	Carbon monoxide, oxygen

Model	Detection target gas
SC-04 (SO ₂)	Sulfur dioxide
SC-04 (NO ₂)	Nitrogen dioxide
SC-04 (HCN)	Hydrogen cyanide
SC-04 (PH ₃)	Phosphine
SC-04 (NH ₃)	Ammonia
SC-04 (CL ₂)	Chlorine

*The carbon monoxide sensor (ESR-A1CP) includes a correction function to reduce hydrogen interference. This function works for hydrogen concentrations up to 2,000 ppm.

1-3. DANGER, WARNING, CAUTION, and NOTE

This operation manual uses the following categories to indicate potential damage/hazards if the user disregards the information provided and uses the product incorrectly:

 DANGER	This indicates situations in which improper handling may result in fatal or serious injury or significant property damage.
 WARNING	This indicates situations in which improper handling may result in serious injury or significant property damage.
 CAUTION	This indicates situations in which improper handling may result in minor injury or minor property damage.

Additionally, usage recommendations are indicated as follows:

NOTE	This indicates items that will be helpful to know when using the product.
-------------	---

1-4. Checking standards and explosion-proof specifications

The product specifications will vary depending on the specific standards and explosion-proof certification. Check the actual product specifications before use. For CE marking models, refer to the Declaration of Conformity at the end of this document.

For product specifications, refer to the nameplate attached to the rear of the product.

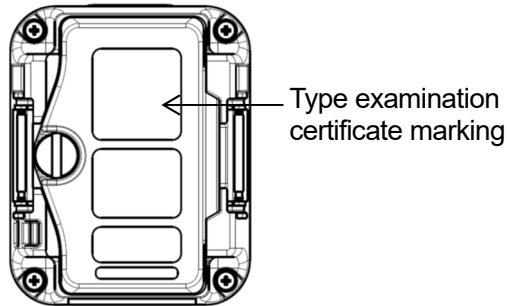

Typical nameplate for models with certificate of conformity for electrical equipment used in potentially explosive atmospheres (Japanese explosion-proof standard)

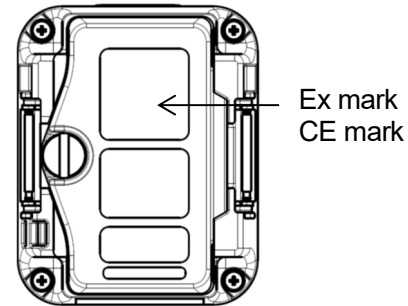

Typical nameplate for ATEX/IECEx models

2

Important Safety Information

To maintain the performance of the product and to ensure safe use, always observe the following DANGER, WARNING, and CAUTION instructions.

2-1. Danger information



Explosion-proofing

- Do not modify or alter the circuitry or configuration.
- When using the product in hazardous areas, take the following precautions to safeguard against static electricity hazards:
 - Wear anti-static clothing and conductive shoes (anti-static work shoes).
 - When using the product indoors, stand on a conductive work floor (with a leakage resistance of 10 MΩ or less).
- Be sure to replace the batteries in a safe place.
- Use the batteries indicated on the certification plate attached to the main unit. The required explosion-proof performance cannot be assured if batteries other than those specified are used.

The battery specifications are as follows:

<Dry cell specifications>

- The explosion-proof class is Ex ia IIC T4 Ga.
- The ratings are as follows:
 - Japan models:
Power source: 3 V DC (Toshiba LR03 battery × 2)
Ambient temperature: -40 °C to +60 °C
 - Export models:
Power source: 3 V DC, 1 mA (Toshiba LR03, Duracell MN2400, or Duracell PC2400 battery × 2)
Ambient temperature: -40 °C to +60 °C
- Does not accept rechargeable batteries.

<Rechargeable battery specifications>

- The explosion-proof class is Ex ia IIC T3 Ga.
- The ratings are as follows:
 - Power source: 2.4 V DC, 1 mA (Panasonic eneloop (BK-4MCC) battery × 2)
 - Ambient temperature: -40 °C to +60 °C
- Use two eneloop (BK-4MCC) (Panasonic) batteries. Does not accept dry cell batteries.
- Use a BQ-CC23 (Panasonic, -Delta Vt control recharging) recharger.
- The rating for recharging is 1.5 V DC, 550 mA.
- Recharge the batteries only in nonhazardous locations.
- If the product is used as an explosion-proof device, note that the explosion-proofing rating conditions specify the battery type to be used.

The battery types are as follows:

<Dry cell specifications>

- Japan models:
Power source: 3 V DC, 1 mA (Toshiba LR03 battery × 2)

• Export models:

Power source: 3 V DC, 1 mA (Toshiba LR03, Duracell MN2400, or Duracell PC2400 battery × 2)

<Rechargeable battery specifications>

eneloop (BK-4MCC) (Panasonic) rechargeable battery × 2

• Guidelines

<Export models (IECEX)>

- IEC 60079-0:2017
- IEC 60079-11:2011

<Export models (ATEX)>

- EN IEC60079-0:2018
- EN60079-11:2012

<Japan models (JPEX)>

- JNIOOSH-TR-46-1:2015
- JNIOOSH-TR-46-6:2015

**DANGER****OX G****OX****CX****Usage**

- When measuring inside manholes or enclosed spaces, never lean over or look into the manhole or enclosed space.
Such locations may generate and discharge oxygen-deficient air or other gases.

2-2. Warning information



WARNING

Air calibration in the atmosphere

- When air calibration is performed in the atmosphere, check the atmosphere for freshness before starting. The presence of interference gases will prevent proper air calibration. The presence of interference gases is also extremely dangerous because the product may not detect actual gas leaks correctly.

Battery level check

- Check battery levels before using the product. The batteries may become depleted if not used for extended periods.

Always replace with new batteries before use.

The battery types are as follows:

<Dry cell specifications>

- Japan models:

Power source: 3 V DC, 1 mA (Toshiba LR03 battery × 2)

- Export models:

Power source: 3 V DC, 1 mA (Toshiba LR03, Duracell MN2400, or Duracell PC2400 battery × 2)

<Rechargeable battery specifications>

eneloop (BK-4MCC) (Panasonic) rechargeable battery × 2

- If a low battery voltage alarm occurs, gas cannot be detected. If a low battery voltage alarm occurs during use, turn off the power and replace the batteries.

Handling the calibration gas

- The calibration gas is nitrogen and a toxic gas. Inhaling the gas may lead to loss of health or even death. When using calibration gas, discharge outside, perform calibration in a well-ventilated area, or use local ventilation equipment.

- For calibration, use a standard gas consisting of the detection target gas diluted with nitrogen or air. Calibration can be performed with a gas mixture that includes other components; however, such calibrations will result in poor sensitivity and inaccurate concentration readings.

Sensor handling

- Never disassemble the sensor inside the product.
Contact with the electrolyte inside the sensor may result in skin inflammation. Contact with eyes may result in blindness. Contact with clothing may result in discoloration or holes. If contact with electrolyte occurs, rinse the area immediately with plenty of water.
- Do not use any gas other than nitrogen as the balance gas when calibrating or adjusting the oxygen sensor.

Miscellaneous

- Do not dispose of the product into fire.
- Do not wash the product, either in a washing machine or an ultrasonic cleaning machine.
- Do not block the buzzer sound opening. Doing so will muffle or silence the audible warning.
- Do not remove the batteries while the power is turned on.



WARNING **CX**

Battery replacement, sensor replacement and filter replacement

- An OVER alarm may occur if the power is turned on within 10 minutes replacing the batteries or the sensor and filter replacement. This is due to the characteristics of the sensor.
If an OVER alarm occurs in fresh air after replacing the batteries the sensor and filter replacement, turn off the power, then turn the power on again after waiting at least 10 minutes.
-

**WARNING NH3****Battery replacement, sensor replacement and filter replacement**

- Immediately after the power is applied, the indication may rise temporarily. This is due to the characteristics of the sensor. When replacing the battery or filter before the battery runs out of power, wait at least 10 minutes, and when replacing the sensor, replacing the battery due to a dead battery, or removing the battery and not using it for a long time, wait at least 120 minutes before turning the power back on.
-

**WARNING CL2****Battery replacement and sensor replacement**

- An OVER alarm may occur if the power is turned on within 10 minutes of replacing the batteries and the sensor replacement. This is due to the characteristics of the sensor.
If an OVER alarm occurs in fresh air after replacing the batteries and the sensor replacement, turn off the power, then turn the power on again after waiting at least 10 minutes.
-

**WARNING****C-****Handling the calibration gas**

- The carbon monoxide sensor with hydrogen compensation must be calibrated separately for carbon monoxide and hydrogen.
 - If hydrogen sensitivity calibration is not performed, carbon monoxide readings may be inaccurate due to hydrogen interference.
 - Due to the hydrogen compensation mechanism, carbon monoxide readings may increase temporarily if hydrogen gas concentrations increase rapidly in the atmosphere being measured.
-

2-3. Caution information



CAUTION

Do not use the product in locations where it may be exposed to oil, chemicals, or other such substances. Avoid deliberately submerging the product in water.

- Do not use the product in locations where it may be exposed to oil, chemicals, liquids, or other such substances.

Do not use walkie-talkies near the product.

- The product's functions may be affected by radio waves emitted from walkie-talkies or other radio transmitters used nearby.

Position any transceivers or other similar devices so that they do not affect the product's functions.

- Avoid using the product near devices that emit strong electromagnetic radiation (high frequency or high voltage devices).

Be sure to perform regular maintenance.

- The product is a safety device. Maintain the product regularly to ensure safety. Continuing to use the product without adequate maintenance will result in sensor sensitivity variations, preventing accurate gas detection.

Maintenance

- Replace filters every six months.
- Handle filters carefully. Do not use this product with damaged filters.

Do not use the product in locations outside the operating temperature and humidity ranges.

- The operating temperature and humidity ranges for the product are as follows. Avoid using the product at temperatures or humidity levels outside the indicated operating range.

OX-04G:

<Continuous use environment> Temperature: -20 °C to +50 °C Humidity: 10 %RH to 90 %RH

OX-04, HS-04, CO-04, CO-04 (C-), CX-04, SC-04 (SO₂, NO₂, PH₃, CL₂):

<Continuous use environment> Temperature: -20 °C to +50 °C Humidity: 10 %RH to 90 %RH

<Temporary use environment> Temperature: -40 °C to +60 °C Humidity: 0 %RH to 95 %RH

SC-04 (HCN):

<Continuous use environment>	Temperature: -20 °C to +50 °C	Humidity: 10 %RH to 90 %RH
<Temporary use environment>	Temperature: -20 °C to +60 °C	Humidity: 0 %RH to 95 %RH

SC-04 (NH3):

<Continuous use environment>	Temperature: -20 °C to +50 °C	Humidity: 10 %RH to 90 %RH
<Temporary use environment>	Temperature: -30 °C to +50 °C	Humidity: 0 %RH to 95 %RH

- Avoid using for extended periods in locations exposed to direct sunlight.
- Avoid storing the product inside parked vehicles in hot weather.
- Note that humidity may affect readings even when humidity is within the specified range.

Air calibration

- Air calibrate the product using fresh air at pressures, temperatures, and humidity levels similar to the actual usage environment.
- Wait for the readout to stabilize before performing air calibration.
- If the temperature difference between the storage location and usage location is 15 °C or greater, turn on the power, allow the product to adjust to ambient conditions similar to those at the usage location for about several tens of minutes^{*1}, and perform air calibration using fresh air before using the product.

Miscellaneous

- Pressing buttons unnecessarily may change settings and prevent alarms from activating correctly. Avoid performing any operations not described in this operation manual.
- Do not drop the product or subject it to impact. Doing so may degrade waterproof and explosion-proof performance or reduce sensitivity.
- Do not poke the sensor or buzzer sound opening with sharp or pointed items. Doing so may result in malfunctions or damage to the product, preventing accurate measurements.
- The product is a precision device. Do not subject the product to strong impact or vibration.
- Keep the product away from magnetic fields. Magnetic fields may cause the product to fail or malfunction. If the product does not operate correctly, use it away from magnetic fields.

Battery replacement

- Replace the batteries promptly (within 10 minutes).

If the product is stored for extended periods with the batteries removed, a [FAIL SENSOR] (sensor abnormality)

alarm may occur in rare cases when the power is turned on. If this occurs, wait several minutes*² before turning the power back on.

- Be sure to turn off the power for the product when replacing the batteries.
- Always replace the batteries with new batteries.
- Note the polarity when inserting the batteries. If inserted with the wrong polarity, the screen for setting date and time will appear the next time the power is turned on.
- Do not use any batteries other than the types specified.
- Be sure to replace the batteries in a safe place.

Storage

- If the product will not be used for extended periods, store with the batteries removed. Battery leaks may result in fire or injury.

*1 OX-04G, SC-04(NH₃): 30 minutes/

OX-04, HS-04, CO-04, CO-04 (C-), CX-04, SC-04 (SO₂, NO₂, HCN, PH₃, CL₂): 10 minutes

*2 OX-04G, HS-04, CO-04, CO-04 (C-), SC-04 (SO₂, NO₂, HCN, PH₃): 5 minutes/

CX-04, SC-04(CL₂): 10 minutes/SC-04(NH₃): 120 minutes/OX-04: Not applicable



CAUTION

OX

CO

HS

C-

CX

SO₂NO₂

HCN

PH₃NH₃CL₂

Gas alarm activation

- If the sensor has been exposed to high concentrations of gas (including the detection target gas or interference gas), it may take several minutes, or even several hours, for the display readout to return to [0 ppm] ([20.9 %] for oxygen). (For example, high concentrations of hydrogen, unsaturated hydrocarbons, alcohol, etc.)

**CAUTION****OX****CX****Oxygen sensor**

- Do not expose the product to sudden pressure fluctuations. Oxygen readings will fluctuate briefly, preventing accurate measurement.
- Do not use any gas other than nitrogen as the balance gas. Otherwise, oxygen reading errors will increase, preventing accurate measurement.

**CAUTION****C-****Calibration**

- Calibration of hydrogen gas may become impossible when the product is used or stored for extended periods in dry environments.
If [FAIL A-CAL] (calibration abnormality) appears during hydrogen sensitivity calibration, leave the product overnight or longer in a location with sufficient humidity, then perform calibration once again. If it is not possible to perform CO sensitivity calibration, contact Riken Keiki to request sensor replacement.

**CAUTION****CX**

- Avoid using the product continuously for extended periods (one day or longer) under a low temperature environment (below $-20\text{ }^{\circ}\text{C}$) or storing it under such environment.

**CAUTION** **SO2** **NO2**

Do not use the product in locations outside the operating temperature and humidity range.

- Due to the filter incorporated into this product, response to gas may slow in high humidity environments.
-

**CAUTION** **NH3**

- There is a possibility of temporary fluctuation of the indication in response to sudden changes in humidity*. Allow the product to blend in sufficiently under the operating environment before turning it on again. Please reconnect the power supply.

*e.g., entering a room from outdoors when it's raining, covering the sensor with your hand

2-4. Safety information

This product is a portable single-gas/two-gas monitor to detect gas.

This product uses two AAA alkaline batteries (Toshiba LR03 or Duracell MN2400/PC2400) or two AAA Ni-MH batteries (Panasonic eneloop (BK-4MCC)) for power supply. Perform battery replacement only in a non-hazardous area.

<Japanese explosion-proof specifications>

Explosion-proof construction	Intrinsically safe explosion-proof construction
Explosion-proof class	Ex ia IIC T4 Ga (Dry cell specifications) Ex ia IIC T3 Ga (Rechargeable battery specifications)
Ambient temperature*	-40 °C to +60 °C
Rating	Power source: Toshiba LR03 battery × 2 (3 V DC, 1 mA)
Applicable guidelines	JNIOSH-TR-46-1: 2015 JNIOSH-TR-46-6: 2015

*The ambient temperature refers to temperatures in the range within which explosion-proof performance can be maintained. It does not imply the temperature range within which the required product performance may be achieved. For information on the operating temperature range, refer to '10. Product Specifications'.

<ATEX/IECEx specifications>

Explosion-proof construction Intrinsically safe explosion-proof construction

Explosion-proof class Ex ia IIC T4/T3 Ga



II 1G Ex ia IIC T4/T3 Ga

Ambient temperature* -40 °C to +60 °C

Electrical specifications T4: Powered by two Toshiba LR03 or Duracell MN2400/PC2400 AAA series-connected alkaline batteries (Use only Toshiba LR03 for Japan models.)

T3: Powered by two Panasonic eneloop (BK-4MCC) series-connected AAA Ni-MH batteries

Certificate numbers

- IECEx: IECEx DEK 19.0059
- ATEX: DEKRA 19 ATEX 0097

Applicable standards

- IEC 60079-0:2017
- IEC 60079-11:2011
- EN IEC 60079-0:2018
- EN60079-11:2012

*The ambient temperature refers to temperatures in the range within which explosion-proof performance can be maintained. It does not imply the temperature range within which the required product performance may be achieved. For information on the operating temperature range, refer to '10. Product Specifications'.

**WARNING**

- Do not replace batteries in hazardous locations.
- Do not attempt to disassemble or alter the product.
- Use only two series-connected AAA alkaline batteries, LR03 manufactured by Toshiba or MN2400/PC2400 by Duracell, or use two series-connected AAA Ni-MH batteries, eneloop (BK-4MCC) manufactured by Panasonic.
 - T4: LR03 manufactured by Toshiba or MN2400/PC2400 by Duracell
(Only LR03 by Toshiba can be used for Japan models.)
 - T3: eneloop (BK-4MCC) manufactured by Panasonic

INST. No. 0 0 0 0 0 0 0 0 0 0
 A B C D E

- A: Manufacturing year (0-9)
B: Manufacturing month (1-9, XYZ for Oct.-Dec.)
C: Manufacturing lot
D: Serial number
E: Code of factory

**RIKEN KEIKI Co., Ltd.**

2-7-6 Azusawa, Itabashi-ku, Tokyo, 174-8744, Japan

Phone: +81-3-3966-1113
Fax: +81-3-3558-9110
Email: intdept@rikenkeiki.co.jp
Website: <https://www.rikenkeiki.co.jp>



3

Product Configuration

3-1. Main unit and accessories

Open the box and packaging and inspect the main unit and accessories.
If anything is missing, contact Riken Keiki.

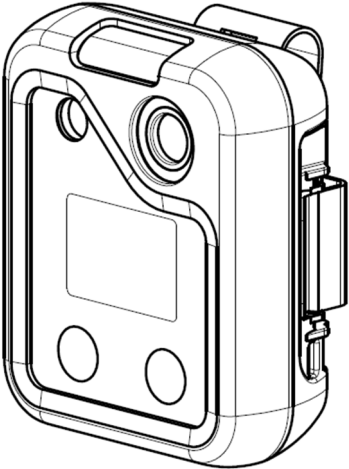
<Main unit and standard accessories>

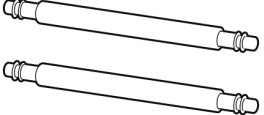
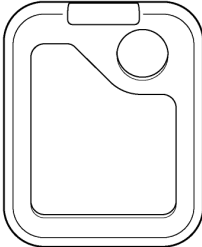
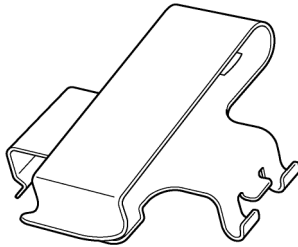
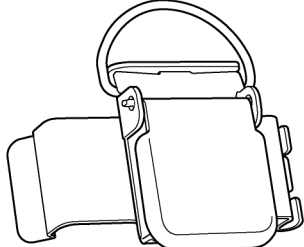
Main unit	Standard accessories		
	Dry cell specifications: AAA alkaline battery × 2 (fitted) Rechargeable battery specifications: AAA Ni-MH battery × 2 (fitted)	Spring bar × 2 (fitted)	Operation manual × 1 Product warranty × 1
			
	Rubber protection cover × 1 (fitted)	Belt clip × 1 (fitted) Japan models	Alligator clip × 1 Export models
			

<Optional items (sold separately)>

- Dust filter (built-in) (Other than SC-04 (CL2))
- Spacer (SC-04 (CL2))
- Filters
 - HS-04, SC-04(PH3): Humidity control filter CF-A13i-1
 - SC-04(NH3): Humidity control filter CF-B134-1
 - CO-04, CO-04 (C-), CX-04: Interference gas removal filter CF-6280
 - SC-04 (SO₂, NO₂): H₂S removal filter CF-A13D-1
 - SC-04 (HCN): H₂S removal filter CF-A13D-3
- Belt clip
- Alligator clip
- Helmet mounting clip (for carbon monoxide sensor)
- Heat-resistant case
- Calibration adapter
- Hand strap
- Band
- Data logger management program

3-2. Part names and functions

3-2-1. Main unit

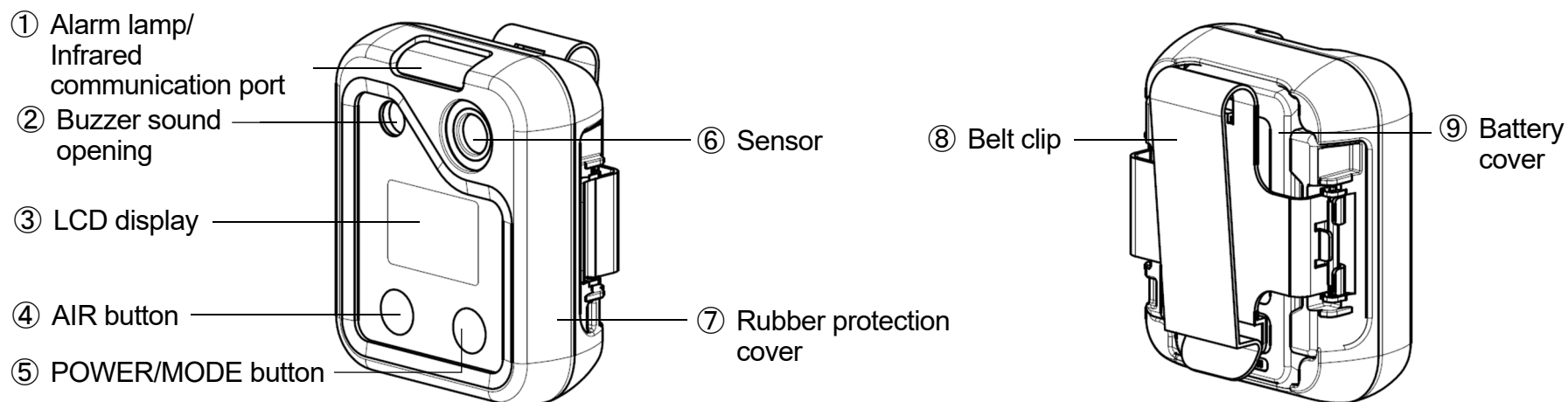

No.	Name	Function
①	Alarm lamp/Infrared communication port	Flashes red when an alarm occurs. This is used for data communication with a PC when using the data logger management program (sold separately)*.
②	Buzzer sound opening	Opening that emits operating and alarm sounds. Blocking the buzzer sound opening will muffle or silence the audible warning.
③	LCD display	Displays the detection target gas name, gas concentration, battery level, etc.

No.	Name	Function
④	AIR button	Performs air calibration in measurement mode. Used to select functions when in user mode, etc.
⑤	POWER/MODE button	Turns the power on/off. Confirms operations when in user mode, etc.
⑥	Sensor	The sensor for detecting gas is installed.
⑦	Rubber protection cover	Cover protecting the product
⑧	Belt clip	Used when clipping to a belt
⑨	Battery cover	Cover protecting the batteries

*The data logger management program is sold separately. For more information, refer to the operating manual for the data logger management program.

3-2-2. LCD display

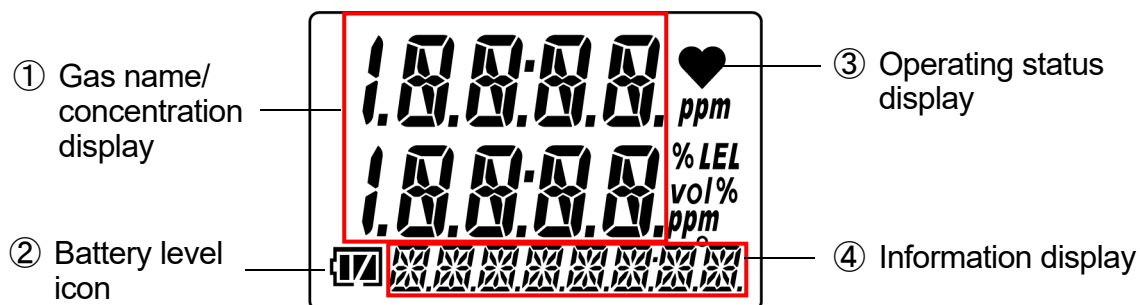

No.	Name	Function
①	Gas name/ concentration display	Displays the detection target gas name and gas concentration.
②	Battery level icon	Indicates battery levels.
③	Operating status display	Indicates the operating status in measurement mode. Blinks when normal. The blinking interval changes from approximately once every second to approximately once every two seconds if no operation is performed for about 30 seconds. In user mode, the blinking interval changes to approximately once every four seconds.
④	Information display	Displays various information.

NOTE

- ▶ The following is a guide to battery levels:

: Sufficient / : Low / : Replace the batteries.

The battery level icon will blink () if battery levels drop even further.

- ▶ If the bump test expiration setting is ON and the bump test expiration date has not passed, [✓] is displayed in the lower part of the LCD. (Refer to '6-4-2. Bump test expiration ON/OFF (BP.RMDR)' in the Technical Manual.)

3-3. Inserting the batteries

When using the product for the first time or when battery levels are low, insert/replace with two new batteries.

The battery types are as follows:

<Dry cell specifications>

• Japan models:

Power source: 3 V DC, 1 mA (Toshiba LR03 battery × 2)

• Export models:

Power source: 3 V DC, 1 mA (Toshiba LR03, Duracell MN2400, or Duracell PC2400 battery × 2)

<Rechargeable battery specifications>

eneloop (BK-4MCC) (Panasonic) rechargeable battery × 2

1 Confirm that the power for the product is turned off.

If the power is on, hold down the POWER/MODE button for at least three seconds to turn off the power.

2 Use a flathead screwdriver to loosen the battery cover retaining screw, then open the battery cover.

If a belt clip has been fitted, open the belt clip.

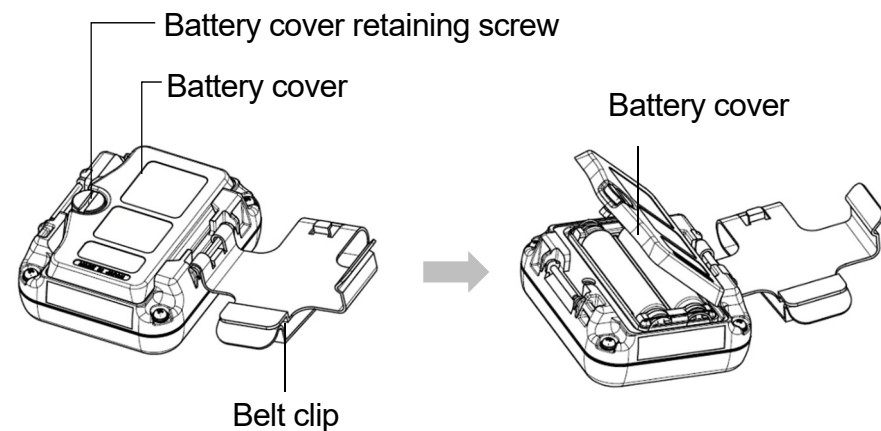

3 Remove the old batteries, then insert new batteries. Note the polarity.

When removing the batteries, push the [+] end toward the [-] end and then lift out. Remove the batteries one at a time.

When inserting the batteries, match the polarity markings to the markings inside the product.

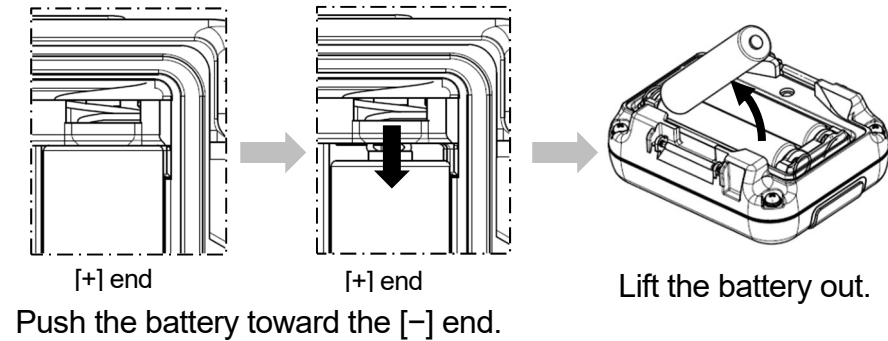
4 Close the battery cover, then tighten the battery cover retaining screw with the flathead screwdriver.**DANGER**

- If the product is used as an explosion-proof device, note that the explosion-proofing rating conditions specify the battery type to be used.

The battery types are as follows:

<Dry cell specifications>

- Japan models:

Power source: 3 V DC, 1mA (Toshiba LR03 battery × 2)

- Export models:

Power source: 3 V DC, 1 mA (Toshiba LR03, Duracell MN2400, or Duracell PC2400 battery × 2)

<Rechargeable battery specifications>

eneloop (BK-4MCC) (Panasonic) rechargeable battery × 2

**WARNING** **CX**

- An OVER alarm may occur if the power is turned on within 10 minutes of replacing the batteries, the sensor and filter replacement. This is due to the characteristics of the sensor. If an OVER alarm occurs in fresh air after replacing the batteries, the sensor and filter replacement, turn off the power, then turn the power on again after waiting at least 10 minutes.

**WARNING** **NH3**

- Immediately after the power is applied, the indication may rise temporarily. This is due to the characteristics of the sensor. When replacing the battery or filter before the battery runs out of power, wait at least 10 minutes, and when replacing the sensor, replacing the battery due to a dead battery, or removing the battery and not using it for a long time, wait at least 120 minutes before turning the power back on.

**CAUTION**

- Be sure to turn off the power for the product when replacing the batteries.
- Always replace with two new batteries of the same type.
- Note the polarity when inserting the batteries.
- Do not use any batteries other than the types specified.
- Be sure to replace the batteries in a safe place.

- The date and time setting screen will appear in the following cases. Set the date and time referring to '6-12. Date and time setting (DATE)' in the Technical Manual.
 - When the batteries are first inserted
 - When the batteries are inserted after the product has been left for five minutes or longer without batteries when replacing the batteries, etc.
 - When the batteries are inserted with the wrong polarity
 - When a button is pressed without batteries when replacing the batteries, etc.

**CAUTION****OX G****CO****HS****C-****SO₂****NO₂****HCN****PH₃**

- The sensor will take about five minutes to stabilize after the batteries are replaced. After replacing the batteries, wait at least five minutes before using the product.

**CAUTION****CX****CL₂**

- The sensor will take about 10 minutes to stabilize after the batteries are replaced. After replacing the batteries, wait at least 10 minutes before using the product.

4

Alarm Functions

4-1. Gas alarm types and alarm setpoints

OX G OX

A gas alarm is triggered if the concentration of the detected gas reaches or exceeds the alarm setpoints shown in the following table. (Self-latching)

Gas alarm types include the first alarm (WARNING), second alarm (ALARM), third alarm (ALARM H), and OVER alarm (OVER).

Alarm type		First alarm (WARNING)	Second alarm (ALARM)	Third alarm (ALARM H)	OVER alarm (OVER)
Measured gas name	Oxygen	18.0 %	18.0 %	25.0 %	40.0 %

CO C-

A gas alarm is triggered if the concentration of the detected gas reaches or exceeds the alarm setpoints shown in the following table. (Japan models: Auto reset/Export models: Self-latching)

Gas alarm types include the first alarm (WARNING), second alarm (ALARM), third alarm (ALARM H), STEL alarm (STEL), integrated alarm (A-1H) or TWA alarm (TWA)*, and OVER alarm (OVER).

Alarm type			First alarm (WARNING)	Second alarm (ALARM)	Third alarm (ALARM H)	STEL alarm (STEL)	Integrated alarm (A-1H)	TWA alarm (TWA)	OVER alarm (OVER)
Measured gas name	Carbon monoxide	Japan	50 ppm	150 ppm	150 ppm	200 ppm	150 ppm	-	2,000 ppm
		Export	25 ppm	50 ppm	1,200 ppm	200 ppm	-	25 ppm	2,000 ppm

*Japan models: Integrated alarm/Export models: TWA alarm

HS

A gas alarm is triggered if the concentration of the detected gas reaches or exceeds the alarm setpoints shown in the following table. (Self-latching)

Gas alarm types include the first alarm (WARNING), second alarm (ALARM), third alarm (ALARM H), STEL alarm (STEL), TWA alarm (TWA), and OVER alarm (OVER).

Alarm type			First alarm (WARNING)	Second alarm (ALARM)	Third alarm (ALARM H)	STEL alarm (STEL)	TWA alarm (TWA)	OVER alarm (OVER)
Measured gas name	Hydrogen sulfide	Japan	1.0 ppm	10.0 ppm	10.0 ppm	5.0 ppm	1.0 ppm	200.0 ppm
		Export	5.0 ppm	30.0 ppm	100.0 ppm	5.0 ppm	1.0 ppm	200.0 ppm



A gas alarm is triggered if the concentration of the detected gas reaches or exceeds the alarm setpoints shown in the following table. (Japan models: Auto reset/Export models: Self-latching)

Gas alarm types include the first alarm (WARNING), second alarm (ALARM), third alarm (ALARM H), STEL alarm (STEL), integrated alarm (A-1H) or TWA alarm (TWA)*, and OVER alarm (OVER).

Alarm type		First alarm (WARNING)	Second alarm (ALARM)	Third alarm (ALARM H)	STEL alarm (STEL)	Integrated alarm (A-1H)	TWA alarm (TWA)	OVER alarm (OVER)	
Measured gas name	Carbon monoxide	Japan	50 ppm	150 ppm	150 ppm	200 ppm	150 ppm	-	2,000 ppm
	Oxygen		18.0 %	18.0 %	25.0 %	-	-	-	40.0 %
	Carbon monoxide	Export	25 ppm	50 ppm	1,200 ppm	200 ppm	-	25 ppm	2,000 ppm
	Oxygen		18.0 %	18.0 %	25.0 %	-	-	-	40.0 %

*Japan models: Integrated alarm/Export models: TWA alarm

SO₂

A gas alarm is triggered if the concentration of the detected gas reaches or exceeds the alarm setpoints shown in the following table. (Self-latching)

Gas alarm types include the first alarm (WARNING), second alarm (ALARM), third alarm (ALARM H), STEL alarm (STEL), TWA alarm (TWA), and OVER alarm (OVER).

Alarm type			First alarm (WARNING)	Second alarm (ALARM)	Third alarm (ALARM H)	STEL alarm (STEL)	TWA alarm (TWA)	OVER alarm (OVER)
Measured gas name	Sulfur dioxide	Japan	2.00 ppm	5.00 ppm	5.00 ppm	5.00 ppm	2.00 ppm	100.00 ppm
		Export	2.00 ppm	5.00 ppm	100.00 ppm	5.00 ppm	2.00 ppm	100.00 ppm

NO₂

A gas alarm is triggered if the concentration of the detected gas reaches or exceeds the alarm setpoints shown in the following table. (Self-latching)

Gas alarm types include the first alarm (WARNING), second alarm (ALARM), third alarm (ALARM H), STEL alarm (STEL), TWA alarm (TWA), and OVER alarm (OVER).

Alarm type			First alarm (WARNING)	Second alarm (ALARM)	Third alarm (ALARM H)	STEL alarm (STEL)	TWA alarm (TWA)	OVER alarm (OVER)
Measured gas name	Nitrogen dioxide	Japan	3.00 ppm	6.00 ppm	6.00 ppm	5.00 ppm	3.00 ppm	20.00 ppm
		Export	2.00 ppm	4.00 ppm	20.00 ppm	1.00 ppm	0.50 ppm	20.00 ppm

HCN

A gas alarm is triggered if the concentration of the detected gas reaches or exceeds the alarm setpoints shown in the following table. (Self-latching)

Gas alarm types include the first alarm (WARNING), second alarm (ALARM), third alarm (ALARM H), STEL alarm (STEL), TWA alarm (TWA), and OVER alarm (OVER).

Alarm type			First alarm (WARNING)	Second alarm (ALARM)	Third alarm (ALARM H)	STEL alarm (STEL)	TWA alarm (TWA)	OVER alarm (OVER)
Measured gas name	Hydrogen cyanide	Japan	4.7 ppm	9.4 ppm	9.4 ppm	4.5 ppm	0.9 ppm	30.0 ppm
		Export	10.0 ppm	20.0 ppm	30.0 ppm	4.5 ppm	0.9 ppm	30.0 ppm

PH3

A gas alarm is triggered if the concentration of the detected gas reaches or exceeds the alarm setpoints shown in the following table. (Self-latching)

Gas alarm types include the first alarm (WARNING), second alarm (ALARM), third alarm (ALARM H), STEL alarm (STEL), TWA alarm (TWA), and OVER alarm (OVER).

Alarm type			First alarm (WARNING)	Second alarm (ALARM)	Third alarm (ALARM H)	STEL alarm (STEL)	TWA alarm (TWA)	OVER alarm (OVER)
Measured gas name	Phosphine	Japan	0.30 ppm	0.60 ppm	0.60 ppm	1.00 ppm	0.30 ppm	20.00 ppm
		Export	0.30 ppm	0.60 ppm	1.00 ppm	1.00 ppm	0.30 ppm	20.00 ppm

NH3

A gas alarm is triggered if the concentration of the detected gas reaches or exceeds the alarm setpoints shown in the following table. (Self-latching)

Gas alarm types include the first alarm (WARNING), second alarm (ALARM), third alarm (ALARM H), STEL alarm (STEL), TWA alarm (TWA), and OVER alarm (OVER).

Alarm type		First alarm (WARNING)	Second alarm (ALARM)	Third alarm (ALARM H)	STEL alarm (STEL)	TWA alarm (TWA)	OVER alarm (OVER)	
Measured gas name	Ammonia	Japan	25.0ppm	35.0ppm	35.0ppm	35.0ppm	25.0ppm	400.0ppm
		Export	25.0ppm	50.0ppm	300.0ppm	35.0ppm	25.0ppm	400.0ppm

CL2

A gas alarm is triggered if the concentration of the detected gas reaches or exceeds the alarm setpoints shown in the following table. (Self-latching)

Gas alarm types include the first alarm (WARNING), second alarm (ALARM), third alarm (ALARM H), STEL alarm (STEL), TWA alarm (TWA), and OVER alarm (OVER).

Alarm type		First alarm (WARNING)	Second alarm (ALARM)	Third alarm (ALARM H)	STEL alarm (STEL)	TWA alarm (TWA)	OVER alarm (OVER)	
Measured gas name	Chlorinea	Japan	0.40ppm	0.80ppm	0.80ppm	1.00ppm	0.50ppm	20.00ppm
		Export	1.00ppm	2.00ppm	10.00ppm	1.00ppm	0.50ppm	20.00ppm

NOTE

- ▶ The default settings for gas alarm setpoints are as shown in the tables above.
 - ▶ The setting values for the alarm setpoints can be changed. (Refer to '6-5. Alarm setpoint setting (ALARM-P)' in the Technical Manual.)
 - ▶ It is recommended that the gas alarm points be used at their default settings.
-

4-2. Gas alarm activation

<Buzzer and alarm lamp patterns>

When a gas alarm occurs, the user will be alerted by the audible buzzer, flashing alarm lamp, and vibration.

The behavior differs depending on the type of alarm.

Alarm type	First alarm (WARNING)	Second alarm (ALARM)	Third alarm (ALARM H)	STEL alarm (STEL)	Integrated alarm (A-1H)	TWA alarm (TWA)	OVER alarm (OVER)
Buzzer	Repeated alternating strong and weak beeps at about 1-second intervals: "Beep, beep"	Repeated alternating strong and weak blips at about 0.5-second intervals: "Blip, blip, blip, blip"	Repeated alternating strong and weak blips at about 0.5-second intervals: "Blip, blip, blip, blip"	Repeated alternating strong and weak beeps at about 1-second intervals: "Beep, beep"	Repeated alternating strong and weak beeps at about 1-second and 0.5-second intervals: "Beep, beep"	Repeated alternating strong and weak beeps at about 1-second intervals: "Beep, beep"	Repeated alternating strong and weak blips at about 0.5-second intervals: "Blip, blip, blip, blip"
Alarm lamp	Repeated flashing at about 1-second intervals	Repeated flashing at about 0.5-second intervals	Repeated flashing at about 0.5-second intervals	Repeated flashing at about 1-second intervals	Repeated alternating flashing at about 1-second and 0.5-second intervals	Repeated flashing at about 1-second intervals	Repeated flashing at about 0.5-second intervals
Vibration	The product will vibrate when an alarm occurs.						

<Gas alarm display>

When a gas alarm occurs, the alarm type is indicated on the LCD display and the corresponding gas concentration display blinks.

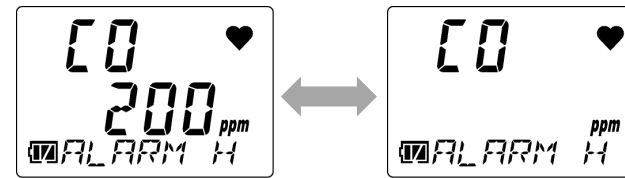

Display example: Carbon monoxide (CO) concentration: 200 ppm when the third alarm is triggered

NOTE

- ▶ If the gas detection range is exceeded (over scale), [OVER] appears on the LCD display, and [□□□□] will blink in the gas concentration display area.

**WARNING**

- A gas alarm indicates the presence of extreme danger. The user must take appropriate action after taking appropriate steps to ensure safety.

NOTE

- ▶ The alarm pattern can be checked in the alarm setpoint display in display mode. Note, however, that the gas concentration display will not blink in alarm tests. (Refer to '7-4. Performing alarm tests' in the Technical Manual.)
- ▶ Press the POWER/MODE button to reset the gas alarm.

4-3. Fault alarm activation

A fault alarm is triggered if an abnormality is detected in the product.

Fault alarm types include system, battery voltage, clock, sensor, and calibration abnormalities.



CAUTION

- If a fault alarm occurs, determine the cause and take appropriate action.
If the problem lies with the product and the fault occurs repeatedly, contact Riken Keiki immediately.

In the event of a fault alarm, the user will be alerted by the audible buzzer and flashing alarm lamp.

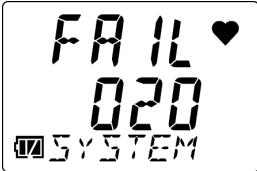
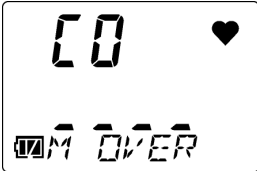
Alarm type	Fault alarm	M OVER alarm (M OVER)
Buzzer	Repeated intermittent beeps at about 1-second intervals: “Beep-beep, beep-beep”	Repeated intermittent beeps at about 1-second intervals: “Beep-beep, beep-beep”
Alarm lamp	Repeated flashing at about 1-second intervals	Repeated flashing at about 1-second intervals
LCD display	 Display example: System abnormality	 Display example: M OVER alarm

NOTE

- ▶ For more information on malfunctions (error messages), see ‘9. Troubleshooting’.
- ▶ The M OVER alarm (minus sensor failure) is an alarm triggered if the zero point falls below the minus side.
- ▶ Press the POWER/MODE button to reset the alarm.

4-4. Outside operating temperature range warning

An outside operating temperature range warning (temperature range error) will be issued if a product (other than the OX-04G) is used for 20 minutes or more outside the operating temperature range.

When a temperature range error occurs, either leave the product for five minutes or longer in the operating temperature range, or turn off the power of the main unit.

If an outside operating temperature range warning occurs, the user will be alerted by the audible buzzer and flashing alarm lamp.

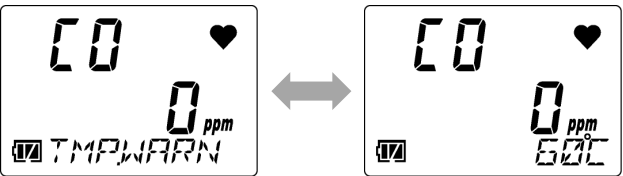
Alarm type	Outside operating temperature range warning
Buzzer	Repeated intermittent beeps at about 1-second intervals: "Beep"
Alarm lamp	Repeated flashing at about 1-second intervals
LCD display	 <p>Display example: Outside operating temperature range warning</p>

NOTE

- ▶ Press the POWER/MODE button to reset the alarm.
- ▶ The outside operating temperature range warning does not apply to the OX-04G.

5

Usage Instruciones

5-1. Usage note

Observe all usage precautions when using the product.

Failure to comply with these precautions may result in failure of the product or inability to perform normal gas measurement.

5-2. Preparing startup

Check the following before starting gas detection:

- Confirm that the protective film on the LCD display has been removed.
- Confirm adequate battery levels.
- Confirm that the filters inside the product are neither contaminated nor clogged.



WARNING

- Protective film is attached to the LCD display of the product at the time of shipping to protect it against scratching.

Be sure to peel off this protective film before using the product. Explosion-proofing cannot be guaranteed if the protective film is left attached.

5-3. Turning on the power

Turn the power on and start the product.

When the power is turned on, various information, including date and time and alarm setpoints, will be displayed in sequence, followed by the measurement mode screen.

1 Hold down the POWER/MODE button (for at least three seconds).

The alarm lamp lights up, and the buzzer blips once.

When the power is turned on, the entire LCD display lights up. The display changes automatically, as shown below.

NOTE

- ▶ When the lunch break ON/OFF (LUNCH) setting is ON, the next time the power is turned on, a confirmation screen displayed for 5 seconds will prompt you to decide whether to continue measurement by retaining the PEAK value and the integrated value (TWA value) from the previous session.

Press the POWER/MODE button to retain the value or the AIR button to reset. The value is retained if no action is taken within five seconds. (Refer to '6-6. Lunch break ON/OFF (LUNCH)' in the Technical Manual.)

The retained or reset gas concentration values are as follows:

OX-04G, OX-04: PEAK value

CO-04, CO-04 (C-), CX-04: Integrated value or TWA value*, PEAK value (*Japan models: Integrated value/Export models: TWA value)

HS-04, SC-04 (SO₂, NO₂, HCN, PH₃, NH₃, CL₂): TWA value, PEAK value

OX G **OX** (Startup time: OX-04G, approx. 20 seconds; OX-04, approx. 40 seconds)

Entire LCD display lights up.

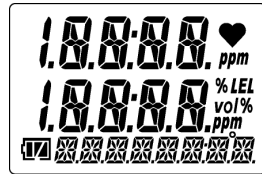

Calibration notification*1



Date and time



Battery level/ alarm pattern



Detection target gas name



The buzzer blips once, and the power turns on.

Full scale

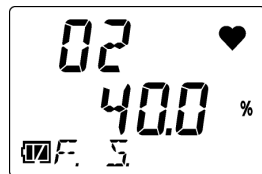

First gas alarm setpoint



Second gas alarm setpoint



Third gas alarm setpoint



Measurement mode



The buzzer blips twice, and the product switches to measurement mode.*2

*1 Japan models: Calibration notification display/Export models: Calibration expiration display

*2 The buzzer does not sound when the key operation tone (KEY.TONE) setting in user mode is set to OFF.

CO **HS** **C-** **SO2** **NO2** **HCN** **PH3** **NH3** **CL2**

(Startup time: approx. 20 seconds)
(Display example: CO-04)

Entire LCD display lights up.

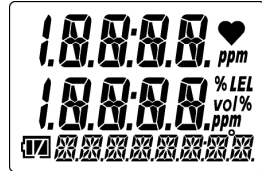

The buzzer blips once, and the power turns on.

Calibration notification*1

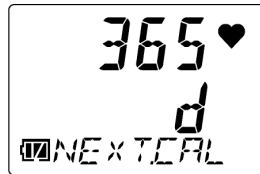

Date and time



Battery level/ alarm pattern



Detection target gas name

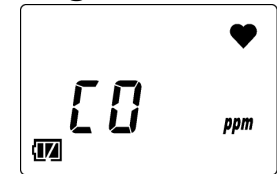

Full scale

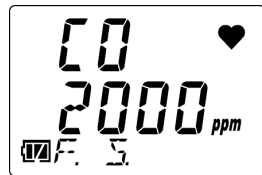

First gas alarm setpoint



Second gas alarm setpoint



Third gas alarm setpoint



STEL alarm setpoint



Integrated/TWA alarm setpoint*2

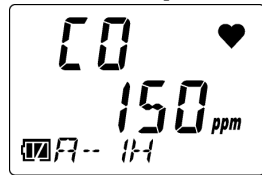

Measurement mode

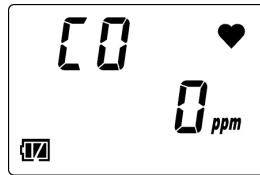

The buzzer blips twice, and the product switches to measurement mode.*3

*1 Japan models: Calibration notification display/Export models: Calibration expiration display

*2 HS-04, SC-04 (SO2, NO2, HCN, NH3, CL2): TWA alarm setpoint

CO-04, CO-04 (C-): Japan models: Integrated alarm setpoint/Export models: TWA alarm setpoint

*3 The buzzer does not sound when the key operation tone (KEY.TONE) setting in user mode is set to OFF.

CX (Startup time: approx. 20 seconds)

Entire LCD display lights up.

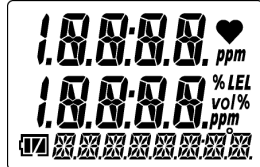

The buzzer blips once, and the power turns on.

Calibration notification*1

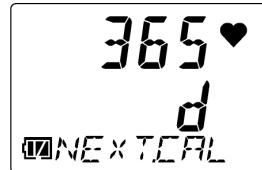

Date and time



Battery level/ alarm pattern



Detection target gas name

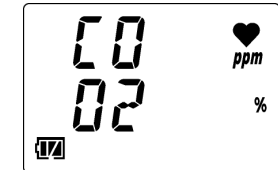

Full scale

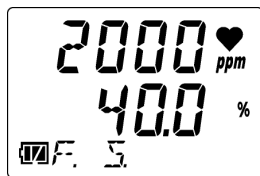

First gas alarm setpoint

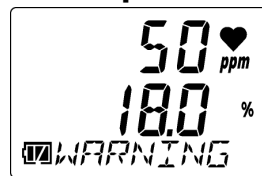

Second gas alarm setpoint

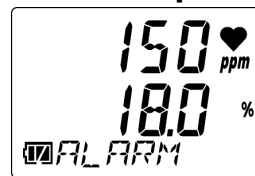

Third gas alarm setpoint

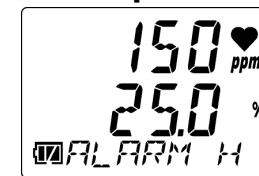

STEL alarm setpoint



Integrated/TWA alarm setpoint*2

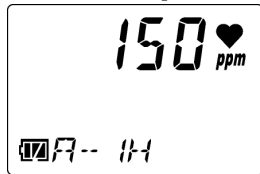

Measurement mode



The buzzer blips twice, and the product switches to measurement mode.*3

*1 Japan models: Calibration notification display/Export models: Calibration expiration display

*2 Japan models: Integrated alarm setpoint/Export models: TWA alarm setpoint

*3 The buzzer does not sound when the key operation tone (KEY.TONE) setting in user mode is set to OFF.

<Basic operation flow>

After turning on the power, the product performs as follows when you press the AIR button or the POWER/MODE button.

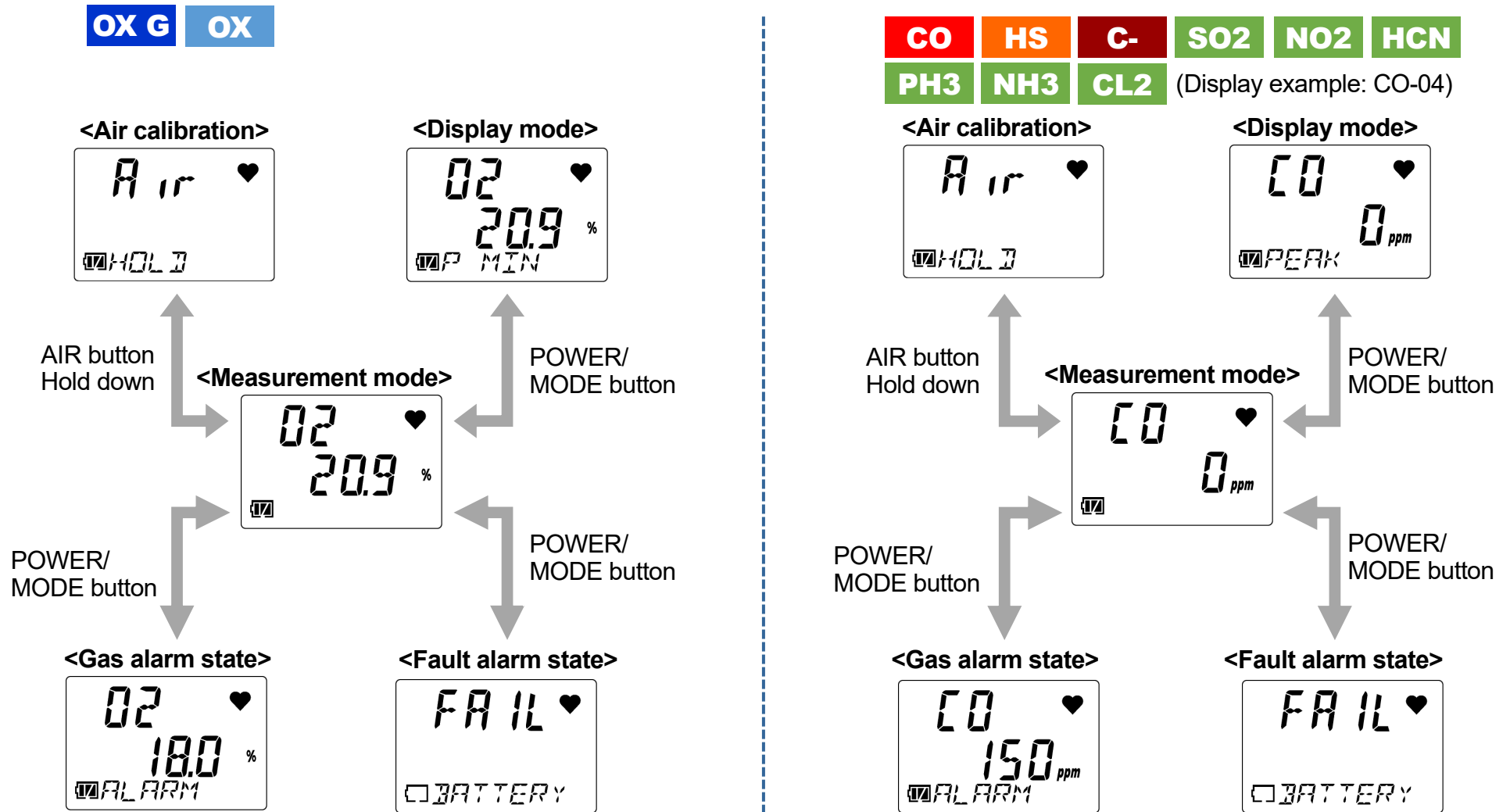

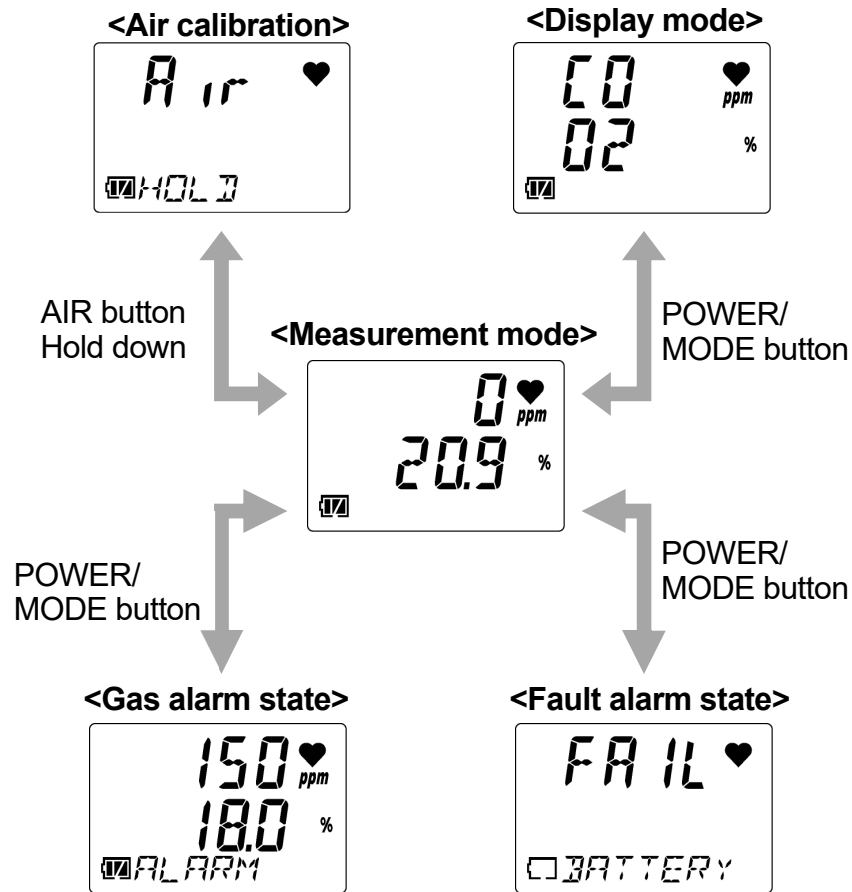

5-4. Performing air calibration

Perform air calibration before measuring gas concentration.

Air calibration refers to zero adjustment required to ensure accurate measurement of gas concentrations.



WARNING

- When air calibration is performed in the atmosphere, check the atmosphere for freshness before starting. The presence of interference gases will prevent proper air calibration. The presence of interference gases is also extremely dangerous because the product may not detect actual gas leaks correctly.



CAUTION

OX**CO****HS****C-****CX****SO₂****NO₂****HCN****PH₃****CL₂**

- Perform air calibration in an environment that meets all of the following conditions:
 - Pressures, temperatures, and humidity levels are similar to pressures, temperatures, and humidity levels in the actual usage environment.
 - In fresh air
- Wait for the readout to stabilize before performing air calibration.
- If the temperature difference between the storage location and usage location is 15 °C or greater, turn on the power and allow the product to adjust to ambient conditions similar to those at the usage location for about 10 minutes. After this, air calibrate in fresh air before use.

**CAUTION OX G NH3**

- Perform air calibration in an environment that meets all of the following conditions:
 - Pressures, temperatures, and humidity levels are similar to pressures, temperatures, and humidity levels in the actual usage environment.
 - In fresh air
- Wait for the readout to stabilize before performing air calibration.
- If the temperature difference between the storage location and usage location is 15 °C or greater, turn on the power and allow the product to adjust to ambient conditions similar to those at the usage location for about 30 minutes. After this, air calibrate in fresh air before use.

1 Hold down the AIR button in measurement mode.

Hold down until the buzzer blips once.
Air calibration starts.

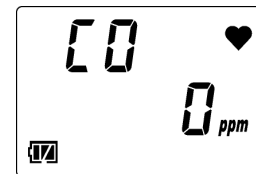
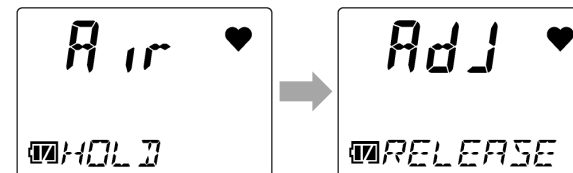
**2 Release the AIR button once the LCD display changes from [Air HOLD] to [AdJ RELEASE].**

The product automatically returns to measurement mode once air calibration has been successfully completed.

NOTE

- ▶ If air calibration fails, [FAIL AIR] will appear. Air calibration will not be performed. Press the POWER/MODE button to reset the fault alarm (calibration abnormality). Resetting the alarm displays the value before air calibration.
 - ▶ If the quick calibration function is enabled, you can perform quick calibration after successful air calibration in measurement mode. To perform quick calibration, hold down the AIR button and release the AIR button when [E-CAL] appears. (Refer to '6-11. Quick calibration time setting (E-CAL)' in the Technical Manual.)
-

5-5. Measuring gas concentration

The product automatically returns to measurement mode once air calibration has been successfully completed to measure the gas concentration.

The gas concentration will appear on the LCD display when measurement is complete.

If the gas concentration detected reaches the alarm setpoint at this time, a gas alarm is triggered. (Refer to '4-2. Gas alarm activation'.)

OX G OX

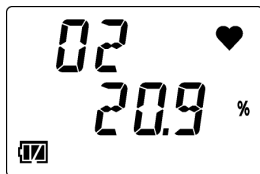

[O₂] (oxygen) gas concentration display

CO HS C- SO₂
NO₂ HCN PH₃ NH₃ CL₂

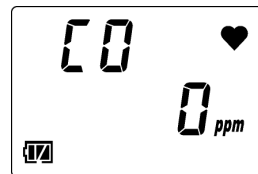

[CO] (carbon monoxide) gas concentration display

CX

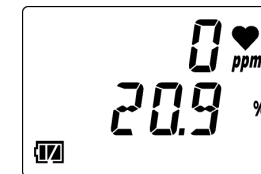

Upper row: [CO] (carbon monoxide) gas concentration display
 Middle row: [O₂] (oxygen) gas concentration display

WARNING

- A gas alarm indicates the presence of extreme danger. The user must take appropriate action after taking appropriate steps to ensure safety.
- Do not block the buzzer sound opening. Doing so will muffle or silence the audible warning.

NOTE

- ▶ When the confirmation beep has been set, the buzzer sounds at the set interval during measurement. (Refer to '6-7. Confirmation beep setting (BEEP)' in the Technical Manual.)
 - ▶ The gas concentration alarm setpoints can be checked in display mode. (Refer to '5-6. Checking the gas concentration, alarm setpoints, etc. (display mode)'.)
 - ▶ The LCD backlight lights up when you press the POWER/MODE button or the AIR button. The LCD backlight will go out after about 30 seconds if no operation is performed. Thirty seconds is the default setting. Change the LCD backlight lighting time in user mode. (Refer to '6-8. LCD lighting time setting (BL TIME)' in the Technical Manual.)
 - ▶ The LCD backlight turns on automatically if an alarm is triggered.
-

5-6. Checking the gas concentration, alarm setpoints, etc. (display mode)

Check measurement results.

Switch to display mode to check items like maximum concentration of gas detected, alarm setpoints, date and time, and temperature. You can also adjust the buzzer volume.

5-6-1. Procedure for displaying display mode

1 Press the POWER/MODE button in measurement mode.

The buzzer blips once, and the product switches to display mode.

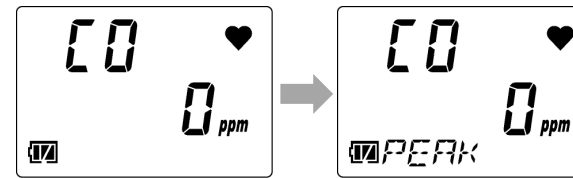

2 Press the POWER/MODE button to cycle through the items displayed.

Pressing the POWER/MODE button cycles through the displayed items.

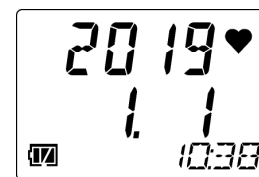



Display example:
With date and time
display selected





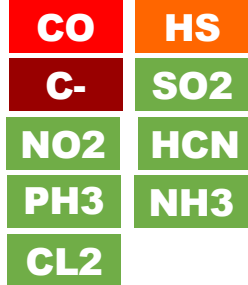

Press the POWER/MODE button in the buzzer volume setting screen to end display mode and return to measurement mode.

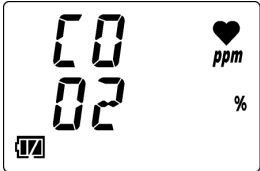



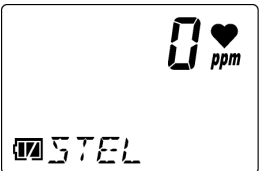
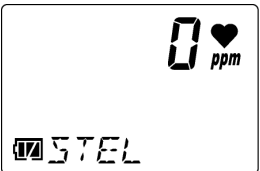

NOTE

- ▶ The product returns automatically to measurement mode if no button operations occur for about 20 seconds.
- ▶ When display mode item display setting (DISP.SET) is OFF, the buzzer volume setting is not displayed. To end display mode, press the POWER/MODE button in the alarm setpoint display screen. (Refer to ‘6-10. Display mode item display ON/OFF (DISP.SET)’ in the Technical Manual.)

5-6-2. Items displayed in display mode

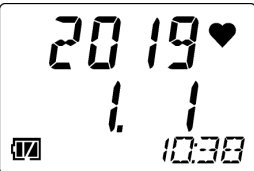
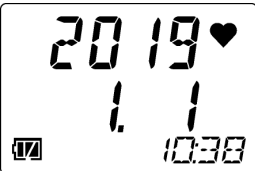
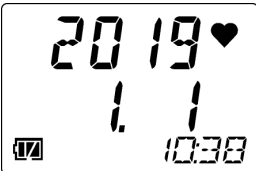
Display item	LCD display			Display contents
		 <p>(Display example: CO-04)</p>		
Detection target gas display	—	—		Displays the name of the detection target gas. [CO] (carbon monoxide) is displayed in the upper row. [O2] (oxygen) is displayed in the middle row.

<p>PEAK display (Lower limit value)</p>		<p>—</p>	<p>—</p>	<p>Displays the minimum gas concentration detected since the power was turned on. You can clear the PEAK value (lower limit value) displayed, by holding down the AIR button until [RELEASE] appears.</p> 
<p>PEAK display (Upper limit value)</p>				<p>Displays the maximum gas concentration detected (minimum oxygen concentration detected for CX-04) since the power was turned on. You can clear the PEAK value (upper limit value) displayed by holding down the AIR button until [RELEASE] appears.</p> <p>(Display example: OX-04G)</p> 
<p>STEL display</p>				<p>The time-weighted average for gas concentration over 15 minutes. The value is refreshed every 60 seconds.</p>

<p>Integrated display or TWA display</p>				<p>Displays the integrated gas concentration value or the TWA value*.</p> <p>The integrated value (A-1H) is the time-weighted average for gas concentration over one hour.</p> <p>The TWA value (TWA) is the time-weighted average of the gas concentration over eight hours per day. The value is refreshed every 60 seconds.</p> <p>* HS-04, SC-04 (SO₂, NO₂, HCN, PH₃, NH₃, CL₂):TWA display * CO-04, CO-04 (C-), CX-04: Japan models: Integrated (A-1H) display/ Export models: TWA display</p>
<p>Date and time display</p>				<p>Displays the current time and date.</p> <p>Display example: January 1, 2019, 10:38</p>
<p>Temperature display</p>				<p>Displays the current temperature.</p> <p>The temperature indicated by the temperature display corresponds to the internal temperature of the product. This value differs from the actual ambient temperature.</p> <p>Display example: 24 °C</p>

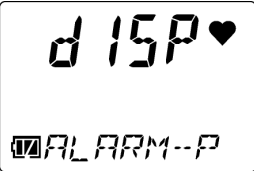
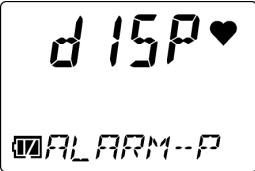
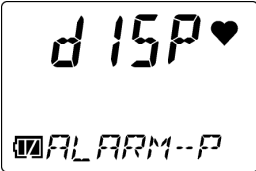
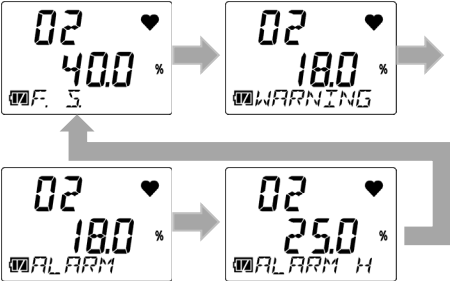
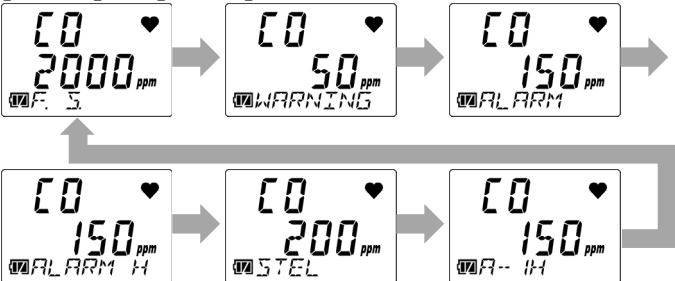
<p>Alarm setpoint display</p>				<p>Displays alarm setpoints. Pressing the AIR button lets you change the alarm setpoint display.</p> <p>[OX-04G, OX-04] Pressing the AIR button cycles through the settings in the following order: [F.S.] (FULL SCALE) → [WARNING] → [ALARM] → [ALARM H].</p>  <p>[CO-04, HS-04, CO-04 (C-), SC-04 (SO2, NO2, HCN, PH3, NH3, CL2)] Pressing the AIR button cycles through the settings in the following order: [F.S.] (FULL SCALE) → [WARNING] → [ALARM] → [ALARM H] → [STEL] → [A-1H] or [TWA]*.</p> 
--------------------------------------	---	---	---	---

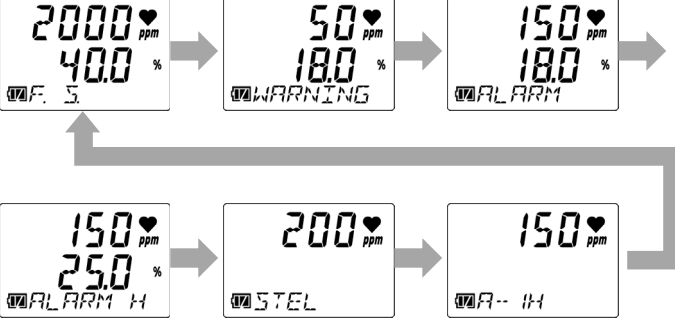
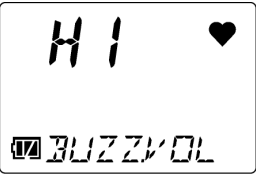
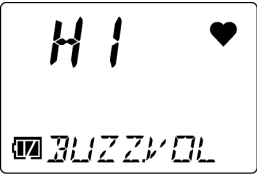
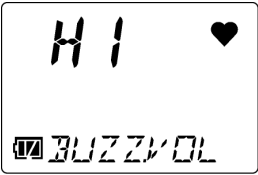
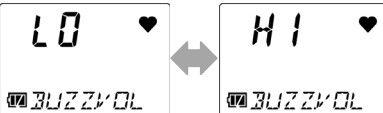
				<p>* HS-04, SC-04 (SO₂, NO₂, HCN, PH₃, NH₃, CL₂): TWA display *CO-04, CO-04 (C-): Japan models: Integrated (A-1H) display/ Export models: TWA display</p> <p>[CX-04] Pressing the AIR button cycles through the settings in the following order: [F.S.] (FULL SCALE) → [WARNING] → [ALARM] → [ALARM H] → [STEL] → [A-1H] or [TWA]*.</p>  <p>* Japan models: Integrated (A-1H) display/Export models: TWA display</p>
<p>Buzzer volume setting</p>				<p>Displays the buzzer volume. Pressing the AIR button lets you change the buzzer volume. Pressing the AIR button toggles the setting between [LO] (soft) and [HI] (loud).</p> 

NOTE

- ▶ By pressing the AIR button and the POWER/MODE button at the same time while displaying any of the alarm setpoints in the alarm setpoint display of display mode, you can test the relevant alarm. (Refer to '7-4. Performing alarm tests' in the Technical Manual.)

5-7. Turning off the power **CAUTION**

- If the concentration display does not return to [0 ppm] (or [20.9 %] for oxygen) when you turn the power off, allow the product to stand in fresh air. Confirm that the display returns to [0 ppm] (or [20.9 %] for oxygen) before turning the power off.

1 Hold down the POWER/MODE button (for at least three seconds).

Hold down until the buzzer blips three times.

[TURN OFF] appears on the LCD. The power turns off.

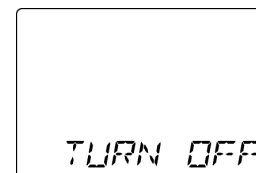

6

User Mode Settings

6-1. User mode setting procedure

Set the date and time, alarm setpoints, and other settings in user mode.

<Displaying the user mode setting screen>

Select the setting item in the user mode menu, then make the settings in the setting screen displayed.

1 Turn off the power.

Hold down the POWER/MODE button for at least three seconds to turn off the power.

2 Hold down the AIR button and the POWER/MODE button at the same time, then release them when the buzzer blips once.

The entire LCD display lights up, and the user mode menu appears.

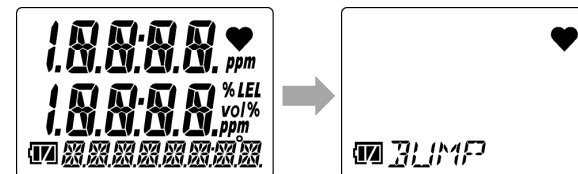

A password input screen will appear if a user mode password was set.

Press the AIR button for each digit to enter the password, then press the POWER/MODE button. The user mode menu will appear when you press the POWER/MODE button after entering the 4th digit.

3 Press the AIR button several times to select the setting item.

Pressing AIR button cycles through user mode menu screens.

For information on user mode setting items, see '6-2. User mode setting items'.

4 Press the POWER/MODE button.

The setting screen appears.

Make the settings in each of the setting screens.

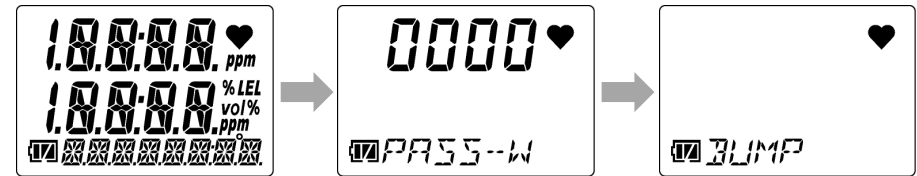

Display example: With date and time setting (DATE) selected

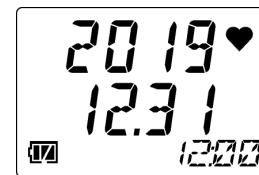

NOTE

- ▶ To display the menu one level higher while configuring settings, hold down the AIR button and the POWER/MODE button at the same time.
- ▶ The user mode password is the four-digit number set in user mode password setting (PASS-W). For information on user mode passwords, see '6-13. User mode password setting (PASS-W)' in the Technical Manual.

<Ending user mode>

- 1 Once the settings are finished, press the AIR button several times to select [START], then press the POWER/MODE button.



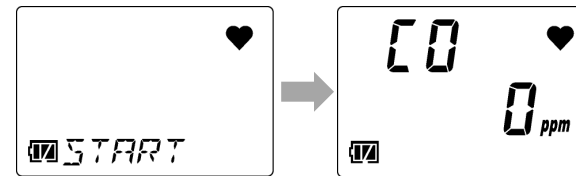

User mode ends. The product returns to measurement mode after performing the same operation as when the power is turned on.



**WARNING**

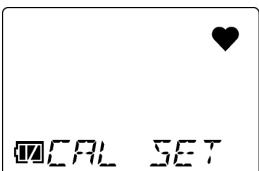

- Be sure to return to measurement mode after user mode settings are complete. The product will not return automatically to measurement mode if left in user mode.



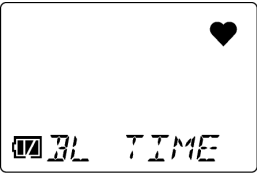

6-2. User mode setting items

The following items can be set in user mode:

Item	LCD display	Details
Bump test (BUMP)		<p>Perform a bump test (function check). The bump test is a test for checking whether the readings are within the acceptable range by introducing a calibration gas. For information on the bump test procedure, see '7-3. Performing bump tests' in the Technical Manual.</p>
Calibration (GAS CAL)		<p>Perform air calibration and AUTO calibration. For information on the calibration procedure, see '7-2. Performing calibration' in the Technical Manual.</p>
Calibration expiration setting (CAL SET)		<p>Toggle the calibration expiration ON/OFF for AUTO calibration, set the number of days for calibration expiration, and set the operation after calibration date expires. *Settings available on export models only</p>
Bump test expiration setting (BUMP.SET)		<p>Set the various conditions for bump testing, toggle the bump test expiration ON/OFF, set the bump test expiration date interval, and set the behavior after bump test expiration.</p>

<p>Alarm setpoint setting (ALARM-P)</p>		<p>Set alarm setpoints*¹. You can also return the alarm setpoints to their default settings.</p> <p>*¹ The following alarm setpoints can be set:</p> <ul style="list-style-type: none"> ▪ OX-04G, OX-04: First to third alarm setpoints ▪ CO-04, CO-04 (C-), CX-04: First to third alarm setpoints, STEL alarm setpoint, integrated alarm setpoint or TWA alarm setpoint*² ▪ HS-04, SC-04 (SO₂, NO₂, HCN, PH₃, NH₃, CL₂): First to third alarm setpoints, STEL alarm setpoint, TWA alarm setpoint <p>*² Japan models: Integrated alarm setpoint/Export models: TWA alarm setpoint</p>
<p>Lunch break ON/OFF (LUNCH)</p>		<p>Set the lunch break setting to ON/OFF. The lunch break function retains the gas concentration values*¹ from the last time the power was turned off and loads them to resume measurement the next time the power is turned on.</p> <p>*¹ The retained gas concentration values are as follows:</p> <ul style="list-style-type: none"> ▪ OX-04G, OX-04: PEAK value ▪ CO-04, CO-04 (C-), CX-04: Integrated value or TWA value*², PEAK value ▪ HS-04, SC-04 (SO₂, NO₂, HCN, PH₃, NH₃, CL₂): TWA value, PEAK value <p>*² Japan models: Integrated value/Export models: TWA value</p>

<p>Confirmation beep setting (BEEP)</p>		<p>Toggle the confirmation beep ON/OFF, set its behavior, and set intervals. This function provides an audible indication of whether the product is operating normally. If the bump test expiration setting (BP.RMDR) or the calibration expiration setting (CAL.RMDR) is ON, you can have this function operate when the expiration date is reached.</p>
<p>LCD lighting time setting (BL TIME)</p>		<p>Set how long the LCD backlight remains on.</p>
<p>Key operation tone ON/OFF (KEY.TONE)</p>		<p>Set the key operation tone ON/OFF.</p>
<p>Display mode item display ON/OFF (DISP.SET)</p>		<p>Set the display ON/OFF for the items that can be set in display mode (buzzer volume setting).</p>

<p>Quick calibration time setting (E-CAL)</p>		<p>Set the time for quick calibration. The quick calibration function performs AUTO calibration after the introduction of the calibration gas by automatically counting down the calibration time set with the quick calibration time setting (E-CAL).</p>
<p>Date and time setting (DATE)</p>		<p>Set the date and time for the internal clock.</p>
<p>User mode password setting (PASS-W)</p>		<p>Set a password when transitioning to user mode. Set a password between 0000 and 9999.</p>
<p>ROM/SUM display (ROM/SUM)</p>		<p>This displays the program number and SUM value of the product. This is normally not set or adjusted by the user.</p>
<p>Measurement start (START)</p>		<p>Return to measurement mode.</p>

7

Maintenance

The product is an important safety and disaster-prevention device.

Perform product maintenance at regular intervals to ensure performance and to improve disaster-prevention and safety reliability.

7-1. Maintenance intervals and maintenance items

Maintain the following items at regular intervals:

- Daily maintenance: Perform maintenance before commencing work.
- Monthly maintenance: Perform alarm tests monthly. (Refer to '7-4. Performing alarm tests' in the Technical Manual.)
- Regular maintenance: Perform maintenance at least once a year (ideally, at least once every six months).

Maintenance item	Maintenance details	Daily maintenance	Monthly maintenance	Regular maintenance
Battery level	Check to confirm that battery levels are adequate.	○	○	○
Concentration display	Check to confirm that the concentration readout is [0 ppm] ([20.9 %] for oxygen) by measuring fresh air. If the readout is not [0 ppm] ([20.9%] for oxygen), check to confirm that no interference gases are present, then perform air calibration.	○	○	○
Main unit operation	Check to confirm that no fault alarm is displayed on the LCD display.	○	○	○

Maintenance item	Maintenance details	Daily maintenance	Monthly maintenance	Regular maintenance
Filters	Check to confirm that the filters are not dirty.	○	○	○
Alarm test	Perform a test. Check to confirm that the alarm lamp, buzzer, and vibration are functioning normally.	—	○	○
Calibration	Perform calibration using a calibration gas.	—	—	○
Gas alarm check	Check the gas alarm using a calibration gas.	—	—	○



WARNING

- If you encounter a product abnormality, contact Riken Keiki immediately.
- When using the SC-04 (HCN), dirt on the face in contact with the CF-A13D-3 does not pose issues.

NOTE

- ▶ Calibration requires dedicated tools and the preparation of a calibration gas. Contact Riken Keiki before performing calibration.
- ▶ The built-in sensor has an expiration date. Replace periodically.
- ▶ The sensor needs to be replaced if you encounter symptoms like failure to restore readings after air calibration or fluctuating readings when performing calibration. Contact Riken Keiki for replacement.

8

Storage and Disposal

8-1. Procedures for storage or when not in use for extended periods

The product must be stored in the following environment:

- In a dark place at normal temperatures and humidity and away from direct sunlight
- In a place free of gases, solvents, and vapor

Store the product in its shipping carton, if retained and available. If the shipping carton is not available, store away from dust and dirt.



CAUTION

- If the product is not to be used for extended periods, store with the battery removed. Battery leaks may result in fire or injury.

<Procedure for reuse>

Perform calibration if the product is used again after a period in storage. (Refer to '3-3. Inserting the batteries', '7-2. Performing calibration' in the Technical Manual.)

8-2. Product disposal

Dispose of the product as industrial waste (incombustible) in accordance with local regulations.

WARNING

- Dispose of batteries in accordance with procedures specified by local authorities.

<Disposal in EU member states>

When disposing of the product in an EU member state, dispose of the batteries separately.

The batteries must be removed and disposed of appropriately in accordance with waste sorting and collection or recycling systems stipulated by the regulations of EU member states.

NOTE

Crossed-out recycle dustbin mark

The pictogram at right indicates that batteries must be separated from ordinary waste and disposed of appropriately.

This is affixed to products containing batteries to which EU Battery Directive 2006/66/EC applies.

Such batteries must be disposed of appropriately.



9

Troubleshooting

9-1. Product abnormalities

Symptom	Cause	Corrective action
The power cannot be turned on.	The batteries are depleted.	Turn off the power and replace with new batteries in a safe place. (Refer to '3-3. Inserting the batteries'.)
	The batteries were inserted with polarity reversed.	Reinsert the batteries correctly. (Refer to '3-3. Inserting the batteries'.)
	The POWER/MODE button was pressed too briefly or for too long.	To turn the power on, hold down the POWER/MODE button for at least three seconds until the buzzer blips once. (Refer to '5-3. Turning on the power'.)
	The battery cover is not closed completely.	Close the battery cover completely.
System abnormality: [FAIL SYSTEM] appears.	A circuit abnormality occurred in the main unit.	Contact Riken Keiki for repair.
Sensor abnormality: [FAIL SENSOR] appears.	The sensor sensitivity has degraded.	Contact Riken Keiki to request sensor replacement. (Refer to '7-6-3. Sensor replacement' in the Technical Manual.)

Symptom	Cause	Corrective action
Low battery voltage alarm: [FAIL BATTERY] appears.	Battery levels are low.	Turn off the power and replace with new batteries in a safe place. (Refer to '3-3. Inserting the batteries'.)
Air calibration is not possible. [FAIL AIR] appears.	Fresh air is not being supplied to the product.	Supply fresh air around the product.
	The sensor sensitivity has degraded.	Contact Riken Keiki to request sensor replacement. (Refer to '7-6-3. Sensor replacement' in the Technical Manual.)
Clock abnormality: [FAIL CLOCK] appears.	Internal clock abnormality	Set the date and time. (Refer to '6-12. Date and time setting (DATE)' in the Technical Manual.) If this occurs frequently, the internal clock may be faulty. Contact Riken Keiki to request internal clock replacement.
The alarm does not stop even after gas concentrations fall below the alarm setpoint.	You did not press the POWER/MODE button.	For OX-04G, OX-04, HS-04, SC-04 (SO₂, NO₂, HCN, PH₃, NH₃, CL₂) The product alarms are self-latching. After the alarm occurs, press the POWER/MODE button. For CO-04, CO-04 (C-), CX-04 If the gas alarm pattern is self-latching, press the POWER/MODE button after the alarm occurs.
System abnormality: [FAIL 031 SYSTEM] appears.	FLASH memory abnormal	If the abnormality is still displayed after turning the power off and on five times or more, contact your dealer or our nearest sales office for repair.

Symptom	Cause	Corrective action
[M-LIMIT] appears.	Calibration notification display * Japan models only	This is the operation when the calibration cycle is reached. After the calibration notice is displayed, It is possible to proceed to the measurement mode by pressing the AIR button. However, be sure to contact your dealer or nearest sales office for maintenance. * In the case of standard setting.
[CAL-LMT] appears.	Calibration expiration display * Export models	Calibration expired operation. After the calibration expiration is displayed, press the POWER/MODE button to proceed to AUTO calibration, or press the AIR button to proceed to measurement mode, but please perform calibration by yourself or ask your dealer or nearest sales office to perform maintenance. * Operation after calibration expires: default setting.
[BP-LMT] appears.	Bump test expiration display	Bump test expired operation. After the bump test expiration is displayed, press the POWER/MODE button to proceed to the bump test. Press AIR button to go to measurement mode, but be sure to perform bump test. * Operation after bump test expires: default setting.

NOTE

- ▶ This troubleshooting section does not address all problems that may occur with the product. Brief explanations of causes and corrective actions have been provided to help correct common problems that may occur frequently. If problems persist even after taking the corrective actions suggested here or if you encounter symptoms not listed here, contact Riken Keiki.

10

Product Specifications

10-1. Common specifications

display	LCD digital display (segments + icons)
Sampling method	Diffusion type
Gas alarm	Three-step alarm, STEL alarm, integrated (for CO models only, Japan models only) or TWA alarm, OVER alarm
Fault alarm	Sensor connection/disconnection, low battery voltage, faulty calibration, clock abnormality, system abnormality
Alarm indications	Flashing lamp, intermittent buzzer sounding, gas concentration display blinking, vibration
Power source	Dry cell specifications: AAA alkaline battery × 2 Rechargeable battery specifications: AAA Ni-MH battery (eneloop) × 2
Protection level	IP66/67 equivalent
Explosion-proof construction	Intrinsically safe explosion-proof construction

Explosion-proof class	<p><Dry cell specifications> Certificate of conformity for electrical equipment used in potentially explosive atmospheres: Ex ia IIC T4 Ga ATEX: II 1G Ex ia IIC T4 Ga IECEX: Ex ia IIC T4 Ga</p> <p><Rechargeable battery specifications> Certificate of conformity for electrical equipment used in potentially explosive atmospheres: Ex ia IIC T3 Ga ATEX: II 1G Ex ia IIC T3 Ga IECEX: Ex ia IIC T3 Ga</p>
Certifications	Certificate of conformity for electrical equipment used in potentially explosive atmospheres, ATEX, IECEX
External dimensions	Approx. 54 mm (W) × 67 mm (H) × 24 mm (D) (excluding projections)
Weight	Approx. 93 g (including batteries)
Functions	Data logger, vibration, STEL alarm, integrated (for CO models only, Japan models only) or TWA alarm, quick calibration, PEAK value display, temperature display

10-2. Specifications by model

Model	OX-04G	OX-04	HS-04	CO-04	CO-04 (C-)	CX-04	
Detection target gas	Oxygen	Oxygen	Hydrogen sulfide	Carbon monoxide	Carbon monoxide (reduced hydrogen interference)	Carbon monoxide	Oxygen
Detection principle	Galvanic cell type	Electrochemical type ^A					
Display name	O2	O2	H2S	CO	CO	CO	O2
Sensor model	OS-BM2 C	ESR-X13P	ESR-A13i	ESR-A13P	ESR-A1CP	ESR-X1DP	
Display range (resolution)	0.0 to 40.0 % (0.1)		0.0 to 30.0 ppm (0.1) 30.0 to 200.0 ppm (1.0)	0 to 300 ppm (1) 300 to 2,000 ppm (10)		0 to 300 ppm (1) 300 to 2,000 ppm (10)	0.0 to 40.0 % (0.1)
Detection range (Japan models)	0.0 to 25.0 %		0.0 to 30.0 ppm	0 to 500 ppm		0 to 500 ppm	0.0 to 25.0 %
Detection range (Export models)	0.0 to 25.0 %		0.0 to 100.0 ppm	0 to 500 ppm		0 to 500 ppm	0.0 to 25.0 %
Alarm setpoints (Japan standard)	L 18.0 % LL 18.0 % H 25.0 % OVER 40.0 %		1st 1.0 ppm 2nd 10.0 ppm 3rd 10.0 ppm TWA 1.0 ppm STEL 5.0 ppm OVER 200.0 ppm		1st 50 ppm 2nd 150 ppm 3rd 150 ppm Integrated 150 ppm STEL 200 ppm OVER 2,000 ppm	1st 50 ppm 2nd 150 ppm 3rd 150 ppm Integrated 150 ppm STEL 200 ppm OVER 2,000 ppm	L 18.0 % LL 18.0 % H 25.0 % OVER 40.0 %
Alarm setpoints (Export standard)	L 18.0 % LL 18.0 % H 25.0 % OVER 40.0 %		1st 5 ppm 2nd 30.0 ppm 3rd 100.0 ppm TWA 1.0 ppm STEL 5.0 ppm OVER 200.0 ppm		1st 25 ppm 2nd 50 ppm 3rd 1,200 ppm TWA 25 ppm STEL 200 ppm OVER 2,000 ppm	1st 25 ppm 2nd 50 ppm 3rd 1,200 ppm TWA 25 ppm STEL 200 ppm OVER 2,000 ppm	L 18.0 % LL 18.0 % H 25.0 % OVER 40.0 %

Alarm permitted setting range	L/LL 0.0 to 20.0 % H 21.8 to 40.0 %		1.0 to 200.0 ppm	20 to 2,000 ppm		20 to 2,000 ppm	L/LL 0.0 to 20.0 % H 21.8 to 40.0 %
Response time*¹ (T90)	Within 20 seconds (Typical: 9 seconds)	Within 20 seconds (Typical: 8 seconds)	Within 30 seconds (Typical: 18 seconds)	Within 30 seconds (Typical: 6 seconds)	Within 30 seconds (Typical: 17 seconds)	Within 30 seconds (Typical: 7 seconds)	Within 30 seconds (Typical: 15 seconds)
Alarm reset operation	Self-latching		Self-latching	Japan models: Auto reset Export models: Self-latching		Japan models: Auto reset Export models: Self-latching	Self-latching
Operating temperature range (no sudden changes)	-20 °C to +50 °C		-40 °C to +60 °C (under temporary use environment for approx. 15 minutes) -20 °C to +50 °C (under continuous use environment)				
Operating humidity range (no condensation)	10 to 90 %RH		0 to 95 %RH (under temporary use environment for approx. 15 minutes) 10 to 90 %RH (under continuous use environment)				
Operating pressure range	80 kPa to 120 kPa (80 kPa to 110 kPa for explosion-proof range)						
Applicable JIS standards	JIS T 8201: 2010	-	JIS T 8205: 2018	-			
Continuous operating time*² (Alkaline batteries)	Approx. 9,000 hours	Approx. 3,000 hours	Approx. 9,000 hours	Approx. 9,000 hours	Approx. 6,200 hours	Approx. 4,600 hours	
Continuous operating time*² (Ni-MH batteries)	Approx. 6,000 hours	Approx. 2,000 hours	Approx. 6,000 hours	Approx. 6,000 hours	Approx. 4,200 hours	Approx. 3,000 hours	

*1 Typical indicates an average value.

*2 25 °C, no alarm, no lighting

10. Product Specifications

10-2. Specifications by model

Model	SC-04 (SO2)	SC-04 (NO2)	SC-04 (HCN)	SC-04(PH3)	SC-04(NH3)	SC-04(CL2)
Detection target gas	Sulfur dioxide	Nitrogen dioxide	Hydrogen cyanide	Phosphine	Ammonia	Chlorine
Detection principle	Electrochemical type					
Display name	SO2	NO2	HCN	PH3	NH3	CL2
Sensor model	ESR-A13D	ESR-A13D	ESR-A13D	ESR-A13D2	ESR-B134	ESR-B136
Display range (resolution)	0.00 to 100.00 ppm (0.05)	0.00 to 20.00 ppm (0.05)	0.0 to 30.0 ppm*3 (0.1)	0.00-20.00 ppm (0.01)	0.0-400.0ppm (0.5)	0.00-20.00ppm (0.05)
Detection range (Japan models)	0.00 to 20.00 ppm	0.00 to 20.00 ppm	0.0 to 30.0 ppm*3	0.00-20.00 ppm	0.0-300.0ppm	0.00-10.00ppm
Detection range (Export models)	0.00 to 20.00 ppm	0.00 to 20.00 ppm	0.0 to 30.0 ppm*3	0.00-20.00 ppm	0.0-300.0ppm	0.00-10.00ppm
Alarm setpoints (Japan standard)	1st 2.00 ppm 2nd 5.00 ppm 3rd 5.00 ppm TWA 2.00 ppm STEL 5.00 ppm OVER 100.00 ppm	1st 3.00 ppm 2nd 6.00 ppm 3rd 6.00 ppm TWA 3.00 ppm STEL 5.00 ppm OVER 20.00 ppm	1st 4.7 ppm 2nd 9.4 ppm 3rd 9.4 ppm TWA 0.9 ppm STEL 4.5 ppm OVER 30.0 ppm	1st 0.30 ppm 2nd 0.60 ppm 3rd 0.60 ppm TWA 0.30 ppm STEL 1.00 ppm OVER 20.00 ppm	1st 25.0ppm 2nd 35.0ppm 3rd 35.0ppm TWA 25.0ppm STEL 35.0ppm OVER 400.0ppm	1st 0.40ppm 2nd 0.80ppm 3rd 0.80ppm TWA 0.50ppm STEL 1.00ppm OVER 20.00ppm
Alarm setpoints (Export standard)	1st 2.00 ppm 2nd 5.00 ppm 3rd 100.00 ppm TWA 2.00 ppm STEL 5.00 ppm OVER 100.00 ppm	1st 2.00 ppm 2nd 4.00 ppm 3rd 20.00 ppm TWA 0.50 ppm STEL 1.00 ppm OVER 20.00 ppm	1st 10.0 ppm 2nd 20.0 ppm 3rd 30.0 ppm TWA 0.9 ppm STEL 4.5 ppm OVER 30.0 ppm	1st 0.30 ppm 2nd 0.60 ppm 3rd 1.00 ppm TWA 0.30 ppm STEL 1.00 ppm OVER 20.00 ppm	1st 25.0ppm 2nd 50.0ppm 3rd 300.0ppm TWA 25.0ppm STEL 35.0ppm OVER 400.0ppm	1st 1.00ppm 2nd 2.00ppm 3rd 10.00ppm TWA 0.50ppm STEL 1.00ppm OVER 20.00ppm
Alarm permitted setting range	0.50 to 100.00 ppm	0.50 to 20.00 ppm	0.9 to 30.0 ppm	0.05 to 20.00	8.0~400.0ppm	0.15~20.00ppm
Response time*1 (T90)	Within 30 seconds (Typical: 9 seconds)	Within 30 seconds (Typical: 6 seconds)	Within 90 seconds (Typical: 36 seconds)	Within 30 seconds (Typical: 6 seconds)	Within 90 seconds (Typical: 30 seconds)	Within 90 seconds (Typical: 36 seconds)
Alarm reset operation	Self-latching					
Operating temperature range (no sudden changes)	-40 °C to +60 °C (under temporary use environment for approx. 15 minutes) -20 °C to +50 °C (under continuous use environment)	-40 °C to +60 °C (under temporary use environment for approx. 15 minutes) -20 °C to +50 °C (under continuous use environment)	-20 °C to +60 °C (under temporary use environment for approx. 15 minutes) -20 °C to +50 °C (under continuous use environment)	-40 °C to +60 °C (under temporary use environment for approx. 15 minutes) -20 °C to +50 °C (under continuous use environment)	-30 °C to +50 °C (under temporary use environment for approx. 15 minutes) -20 °C to +50 °C (under continuous use environment)	-40 °C to +60 °C (under temporary use environment for approx. 15 minutes) -20 °C to +50 °C (under continuous use environment)
Operating humidity range (no condensation)	0 to 95 %RH (under temporary use environment for approx. 15 minutes) 10 to 90 %RH (under continuous use environment)					

Operating pressure range	80 kPa to 120 kPa (80 kPa to 110 kPa for explosion-proof range)
Continuous operating time^{*2} (Alkaline batteries)	Approx. 3,000 hours
Continuous operating time^{*2} (Ni-MH batteries)	Approx. 2,000 hours

*1 Typical indicates an average value.

*2 25 °C, no alarm, no lighting

*3 The SC-04 (HCN) indicates 0.0 ppm between 0.0 and 0.2 ppm.

11

Appendix

11-1. Limited Warranty and Limitation Liability

RIKEN KEIKI CO.,LTD. (RIKEN) warrants the product to be free from defects in material and workmanship under normal use and service for a period of the number of years to be listed in "Table: List of warranty years", beginning on the date of shipment to the buyer. This warranty extends only to the sale of new and unused products to the original buyer. RIKEN's warranty obligation is limited, at RIKEN's option, to repair or replacement of a defective product that is returned to a RIKEN KEIKI Quality control center located in Japan within the warranty period. In no event shall RIKEN's liability hereunder exceed the purchase price actually paid by the buyer for the Product.

This warranty does not include:

- a) fuses, disposable batteries or the routine replacement of parts due to the normal wear and tear of the product arising from use;
- b) any product which in RIKEN's opinion, has been misused, altered, neglected or damaged, by accident or abnormal conditions of operation, handling or use;
- c) any damage or defects attributable to repair of the product by any person other than an authorized dealer, or the installation of unapproved parts on the product; or

The obligations set forth in this warranty are conditional on:

- a) proper storage, installation, calibration, use, maintenance and compliance with the product manual instructions and any other applicable recommendations of RIKEN;
- b) the buyer promptly notifying RIKEN of any defect and, if required, promptly making the product available for correction. No goods shall be returned to RIKEN until receipt by the buyer of shipping instructions from RIKEN; and
- c) the right of RIKEN to require that the buyer provide proof of purchase such as the original invoice, bill of sale or packing slip to establish that the product is within the warranty period.

THE BUYER AGREES THAT THIS WARRANTY IS THE BUYER'S SOLE AND EXCLUSIVE REMEDY AND IS IN LIEU OF ALL OTHER WARRANTIES, EXPRESS OR IMPLIED, INCLUDING BUT NOT LIMITED TO ANY IMPLIED WARRANTY OF MERCHANTABILITY OR FITNESS FOR A PARTICULAR PURPOSE. RIKEN SHALL NOT BE LIABLE FOR ANY SPECIAL, INDIRECT, INCIDENTAL, OR BASED ON CONTRACT, TORT OR RELIANCE OR ANY OTHER THEORY.

Since some countries or states do not allow limitation of the term of an implied warranty, or exclusion or limitation of incidental or consequential damages, the limitations and exclusions of this warranty may not apply to every buyer. If any provision of this warranty is held invalid or unenforceable by a court of competent jurisdiction, such holding will not affect the validity or enforceability of any other provision.

Contacting RIKEN KEIKI

Email us at: intdept@rikenkeiki.co.jp

Visit RIKEN KEIKI website at: <https://www.rikenkeiki.com/>

JAPAN: +81-3-3966-1113

Table: List of warranty years

Product warranty					
3 years					
Sensor warranty					
Sensor model	Detection target gas	Warranty	Sensor model	Detection target gas	Warranty
OS-BM2 C	Oxygen (O ₂)	1 year	ESR-A13D	Sulfur dioxide (SO ₂)	3 years
ESR-X13P	Oxygen (O ₂)	3 years	ESR-A13D	Nitrogen dioxide (NO ₂)	3 years
ESR-A13i	Hydrogen sulfide (H ₂ S)	3 years	ESR-A13D	Hydrogen cyanide (HCN)	3 years
ESR-A13P	Carbon monoxide (CO)	3 years	ESR-A13D2	Phosphine (PH ₃)	3 years
ESR-A1CP	Carbon monoxide (CO) (reduced hydrogen Interference)	3 years	ESR-B134	Ammonia (NH ₃)	1 years
ESR-X1DP	Carbon monoxide (CO) / Oxygen (O ₂)	3 years	ESR-B136	Chlorine (CL ₂)	1 years

Revision History

Issue	Revision details	Issue date
0	First issue *Corresponds to Technical Manual PT0-1940.	2020/1/23
1	Added 1-4. Checking standards and explosion-proof specifications/Changed CF-1821 to CF-6280 (CO-04, CX-04)/Other amendments made to wording *Corresponds to Technical Manual PT0E-1941.	2020/4/9
2	Revised 2-4. Safety information/Added description to 10-2. Specifications by model/Added "SC-04 (NO2, HCN)"/modified "SC-04 (SO2) alarm setting range" *Corresponds to Technical Manual PT0E-1942.	2020/11/25
3	Added 11-1. Limited Warranty and Limitation Liability *Corresponds to Technical Manual PT0E-1943.	2021/3/25
4	Correction「9. Troubleshooting」 *Corresponds to Technical Manual PT0E-1944	2021/6/4
5	Added "SC-04 (PH3)" *Corresponds to Technical Manual PT0E-1945	2021/7/19
6	Added "SC-04 (NH3)" *Corresponds to Technical Manual PT0E-1946	2021/9/3
7	Added "SC-04 (CL2)" *Corresponds to Technical Manual PT0E-1947	2021/10/14



EU-Declaration of Conformity

Document No.: 320CE21083



We, RIKEN KEIKI Co., Ltd. 2-7-6, Azusawa, Itabashi-ku, Tokyo, 174-8744 Japan declare under our sole responsibility that the following product conforms to all the relevant provisions.

Product Name: Portable Gas Monitor
Model: OX-04,OX-04G,HS-04,CO-04,CX-04,SC-04

Council Directives	Applicable Standards
2014/34/EU ATEX Directive	EN IEC 60079-0:2018 EN 60079-11:2012
2014/30/EU EMC Directive	EN 50270:2015
2011/65/EU RoHS Directive	EN IEC 63000:2018

EU-Type examination Certificate No. DEKRA 19ATEX0097

Notified Body for ATEX

DEKRA Certification B.V. (NB 0344)
Meander 1051,6825 MJ Arnhem
P.O.Box5185,6802 ED Arnhem
The Netherlands

Auditing Organization for ATEX

DNV Product Assurance AS (NB 2460)
Veritasveien 3
1363 Høvik
Norway

The marking of the product shall include the following:

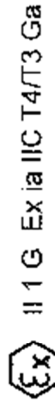

Alternative Marking: T4:when equipped with primary batteries
T3:when equipped with secondary batteries

Place: Tokyo, Japan

Date: Sep. 22, 2021

Takakura Toshiyuki
General manager
Quality Control Center